

- For level detection of electrically conductive and non-conductive fluids
- Compact miniature performance
- Easy setting by means of magnetic pen
- Direct mounting to vessels, tanks, sumps, tubes
- High temperature performance available
- Outputs S, PNP, NAMUR
- LED state indication \*



**Capacitive level sensors (switches) CLS-23** are designed for limit level detection of electrically conductive and non-conductive fluids in vessels, reservoirs, sumps, pipes, tanks, etc. The sensitivity of the sensor can be easily set by placing magnetic pen on sensitive spot.

The process coupling at the housing can be with metric thread (M18x1.5 ; M20x1.5), pipe thread (G3/8" ; G1/2") or sealing thread (NPT 1/2-14). Output performances – transistor output with open collector (PNP), two wire electronic switch (S) and NAMUR output.

There are next performances available: **N** – Normal for non-explosive areas, **E** – Extended temperature range for non-explosives areas, **Xi** – Explosion proof (intrinsically safe for explosive areas), **NT** – High temperature variant for non-explosives areas and **XIT** – High temperature variant for explosive areas.

### FEATURES OF VARIANTS

- |                   |   |
|-------------------|---|
| <b>CLS-23_-10</b> | <b>Uncoated short bar electrode</b> , for sensing of electrically non-conductive liquids (mineral and plant oils, resins, etc.). Mounting in horizontal position.<br>Electrode length 30 mm.  |
| <b>CLS-23_-11</b> | <b>Insulated (coated) short bar electrode</b> , for non-aggressive electrically conductive liquid sensing (water, water solutions). The insulation is made from PP (Polypropylene).<br>Electrode length 30 mm.  |
| <b>CLS-23_-12</b> | <b>Insulated (coated) short bar electrode</b> , for moderately aggressive electrically conductive liquid sensing (chemicals, water, moderately aggressive water solutions). Higher temperature resistance than variant "11". The insulation is made from FEP (Tetrafluoroethylene-Perfluoro-Propylene).<br>Electrode length 30 mm   |
| <b>CLS-23_-20</b> | <b>Partly insulated rod electrode</b> , for level detection of conductive and non-conductive liquids, partially resistant to vapours (water) condensation in the sensing area. The insulation is made from FEP. Vertical mounting; horizontal mounting (from the side) is possible for shorter electrodes (up to 200 mm)<br>Electrode length from 50 mm to 1 m.   |
| <b>CLS-23_-21</b> | <b>Fully insulated rod electrode</b> , for universal use, for level detection of conductive liquids (water, water solutions). Resistant to vapours (water) condensation in the sensing area and partially resistant to medium spraying. The insulation is made from FEP. Vertical mounting; horizontal mounting (from the side) is possible for shorter electrodes (up to 200 mm).<br>Electrode length from 50 mm to 1 m. |
| <b>CLS-23_-30</b> | <b>Uncoated removable rod electrode</b> , for level detection of conductive and non-conductive liquids. Vertical mounting; horizontal mounting (from the side) is possible for shorter electrodes (up to 200 mm).<br>Electrode length from 50 mm to 1 m.  |

\* Variant "E" without LED state indicator

# DIMENSIONS DRAWINGS

CLS-23\_-10

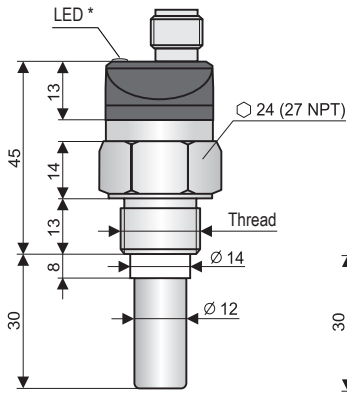

CLS-23\_-11

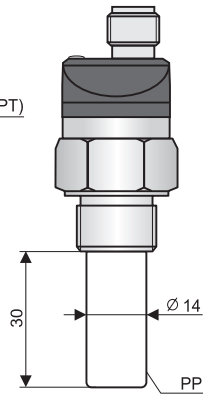

CLS-23\_-12

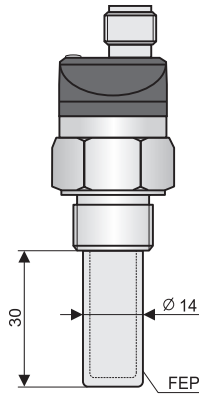

CLS-23\_-20

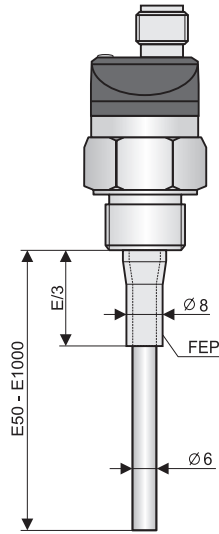

CLS-23\_-21

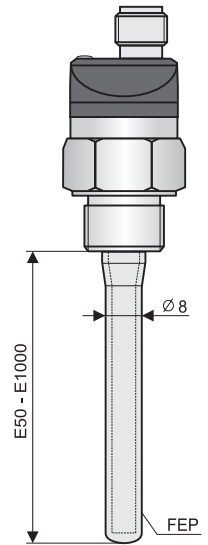

Types of threads:  
 G 3/8"  
 M18x1,5  
 M20x1,5  
 1/2-14 NPT

CLS-23\_-30

High temperature variants  
 (CLS-23\_T-10; 12; 20; 21; 30)

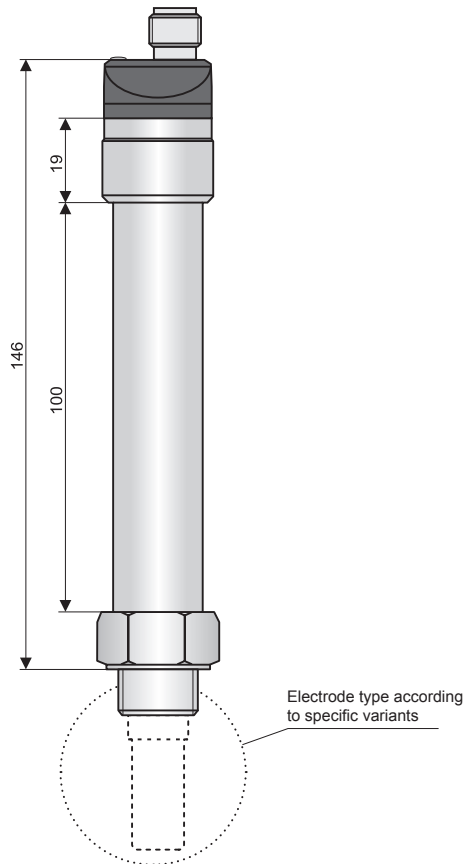
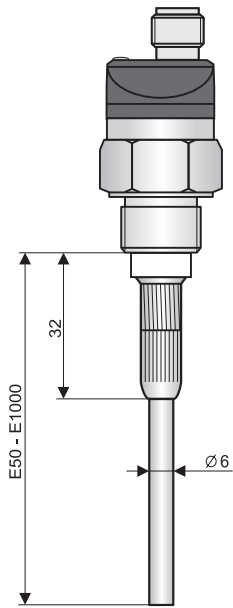

Variant "C" with connector  
 (except CLS-23E)

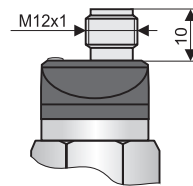

Variant "A" with cable outlet

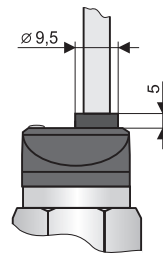

Magnetic pen MP-8

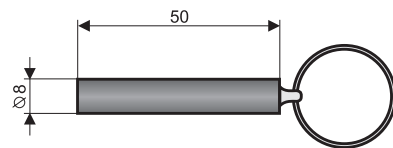

\* Variant "E" without LED state indicator

TECHNICAL SPECIFICATIONS		
Supply voltage		6 ... 30 V DC
Supply current	– Output type P – Output type S	max. 0.6 / 7 mA (OFF / ON state) max. 0.6 mA (OFF state)
Switched current (Min. / Max.)	– Output type P – Output type S	100 mA 3.3 mA / 40 mA (Min. / Max.)
Remanent voltage – ON state	– Output type P – Output type S	1.8 V 6.0 V
Output time delay		0.1 s
Protection class		IP68 (0.1 MPa)
Cable (for cable outlet performance)	CLS–23N, NT, Xi, XiT CLS–23E	PVC 2x 0.34 mm <sup>2</sup> (3x 0.34 mm <sup>2</sup> – Output type P) Silicone 2x 0.5 mm <sup>2</sup>
Weight (with 2 m cable and 30 mm electrode)	CLS–23N, E, Xi CLS–23NT, XiT	Approx. 45 g Approx. 190 g

ELECTRICAL PARAMETERS – variants Xi, XiT	
Supply voltage	8 ... 9 V DC
Current supply (state OFF / ON) – NAMUR	≤ 1 mA / ≥ 2,2 mA
Max. internal values	Ui= 12 VDC; li= 15 mA; Pi= 45 mW; Ci= 15 nF; Li= 10 μH
Coupling capacity / Electric strength	44 nF / 250 V AC
Cable LC parameters	Typical C < 150 pF/m; L < 0.8 μH / m

TEMPERATURE AND PRESSURE RESISTANCE – variants N, E, NT								
Variant (Performance)	Temperature tp	Temperature tm	Temperature ta	Max. operating pressure for temperature tp				
				to 30°C	to 85°C	to 105°C	to 130°C	to 150°C
CLS–23N–10	-25°C ... +105°C	-25°C ... +105°C	-20°C ... +80°C	8 MPa	6 MPa	5 MPa	–	–
CLS–23E–10	-25°C ... +120°C	-25°C ... +120°C	-25°C ... +105°C	8 MPa	6 MPa	5 MPa	–	–
CLS–23NT–10	-30°C ... +150°C	-30°C ... +150°C	-20°C ... +80°C	8 MPa	6 MPa	5 MPa	4 MPa	3 MPa
CLS–23N–11	-10°C ... +105°C	-10°C ... +105°C	-10°C ... +80°C	7 MPa	5 MPa	4 MPa	–	–
CLS–23E–11	-10°C ... +105°C	-10°C ... +105°C	-10°C ... +105°C	7 MPa	5 MPa	4 MPa	–	–
CLS–23N–12	-25°C ... +105°C	-25°C ... +105°C	-20°C ... +80°C	8 MPa	6 MPa	5 MPa	–	–
CLS–23E–12	-25°C ... +120°C	-25°C ... +120°C	-25°C ... +105°C	8 MPa	6 MPa	5 MPa	–	–
CLS–23NT–12	-30°C ... +150°C	-30°C ... +150°C	-20°C ... +80°C	8 MPa	6 MPa	5 MPa	4 MPa	3 MPa
CLS–23N–20	-25°C ... +105°C	-30°C ... +150°C*	-20°C ... +80°C	3 MPa	2.5 MPa	2 MPa	–	–
CLS–23E–20	-25°C ... +120°C	-30°C ... +150°C*	-25°C ... +105°C	3 MPa	2.5 MPa	2 MPa	–	–
CLS–23NT–20	-30°C ... +150°C	-30°C ... +150°C	-20°C ... +80°C	3 MPa	2.5 MPa	2 MPa	1.5 MPa	1 MPa
CLS–23N–21	-25°C ... +105°C	-30°C ... +150°C*	-20°C ... +80°C	3 MPa	2.5 MPa	2 MPa	–	–
CLS–23E–21	-25°C ... +120°C	-30°C ... +150°C*	-25°C ... +105°C	3 MPa	2.5 MPa	2 MPa	–	–
CLS–23NT–21	-30°C ... +150°C	-30°C ... +150°C	-20°C ... +80°C	3 MPa	2.5 MPa	2 MPa	1.5 MPa	1 MPa
CLS–23N–30	-25°C ... +105°C	-30°C ... +150°C*	-20°C ... +80°C	8 MPa	6 MPa	5 MPa	–	–
CLS–23E–30	-25°C ... +120°C	-30°C ... +150°C*	-25°C ... +105°C	8 MPa	6 MPa	5 MPa	–	–
CLS–23NT–30	-30°C ... +150°C	-30°C ... +150°C	-20°C ... +80°C	8 MPa	6 MPa	5 MPa	4 MPa	3 MPa

\* Valid for top mounting (in vertical position)

TEMPERATURE AND PRESSURE RESISTANCE – variants Xi, XiT								
Variant (Performance)	Temperature tp	Temperature tm	Temperature ta	Max. operating pressure for temperature tp				
				to 30°C	to 85°C	to 105°C	to 130°C	to 150°C
CLS–23Xi–10	-25°C ... +105°C	-25°C ... +105°C	-20°C ... +75°C	8 MPa	6 MPa	5 MPa	–	–
CLS–23XiT–10	-30°C ... +150°C	-30°C ... +150°C	-20°C ... +75°C	8 MPa	6 MPa	5 MPa	4 MPa	3 MPa
CLS–23Xi–11	-10°C ... +105°C	-10°C ... +105°C	-10°C ... +75°C	7 MPa	5 MPa	4 MPa	–	–
CLS–23Xi–12	-25°C ... +105°C	-25°C ... +105°C	-20°C ... +75°C	8 MPa	6 MPa	5 MPa	–	–
CLS–23XiT–12	-30°C ... +150°C	-30°C ... +150°C	-20°C ... +75°C	8 MPa	6 MPa	5 MPa	4 MPa	3 MPa
CLS–23Xi–20	-25°C ... +105°C	-30°C ... +150°C*	-20°C ... +75°C	3 MPa	2.5 MPa	2 MPa	–	–
CLS–23XiT–20	-30°C ... +150°C	-30°C ... +150°C	-20°C ... +75°C	3 MPa	2.5 MPa	2 MPa	1.5 MPa	1 MPa
CLS–23Xi–21	-25°C ... +105°C	-30°C ... +150°C*	-20°C ... +75°C	3 MPa	2.5 MPa	2 MPa	–	–
CLS–23XiT–21	-30°C ... +150°C	-30°C ... +150°C	-20°C ... +75°C	3 MPa	2.5 MPa	2 MPa	1.5 MPa	1 MPa
CLS–23Xi–30	-25°C ... +105°C	-30°C ... +150°C*	-20°C ... +75°C	8 MPa	6 MPa	5 MPa	–	–
CLS–23XiT–30	-30°C ... +150°C	-30°C ... +150°C	-20°C ... +75°C	8 MPa	6 MPa	5 MPa	4 MPa	3 MPa

\* Valid for top mounting (in vertical position)

PROCESS CONNECTION		
Type	Size	Marking
Metric thread	M18x1.5	<b>M18</b>
Metric thread	M20x1.5	<b>M20</b>
Pipe thread (BSP)	G 3/8"	<b>G3/8</b>
Pipe thread (BSP)	G 1/2"	<b>G1/2</b>
Sealing thread	1/2-14	<b>NPT</b>

OUTPUT TYPE	
Output	Variants
S	N, E, NT
PNP	N, E, NT
NAMUR	Xi, XiT

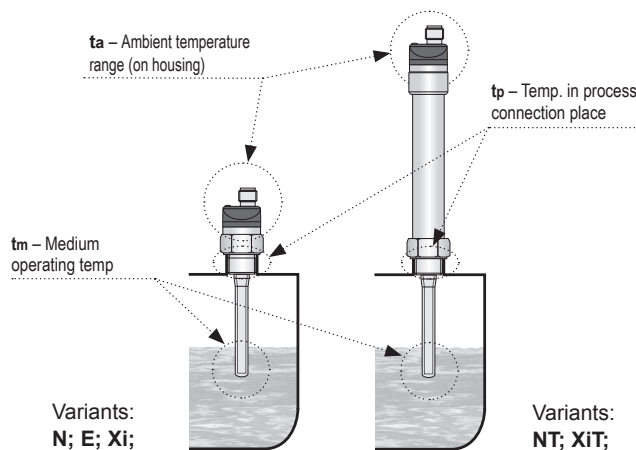

MATERIAL PERFORMANCE		
Sensor part	Variants	Material
Housing	All variants	Plastic PP
Process coupling	All variants	Stainless steel W.Nr. 1.4305 (AISI 303)
Electrode	All variants	Stainless steel W.Nr. 1.4305 (AISI 303)
Electrode insulation	CLS-23_-11	Plastic PP
Electrode insulation	CLS-23_-12, 20, 21	Plastic FEP

WORKING AREAS (EN 60079-10-1)	
CLS-23N	Performance for non-explosive areas
CLS-23E	Extended temperature performance for non-explosive areas
CLS-23NT	High temperature performance for non-explosive areas
CLS-23Xi(XiT)-10 CLS-23Xi(XiT)-30	Performance for explosive areas (XiT-high temperature), $\text{Ex II 1/2 G Ex ia IIC T6 Ga/Gb}$ with intrinsically safe supply units, electrode part zone 0, housing zone 1
CLS-23Xi-11, 12, 20, 21	Performance for explosive areas, $\text{Ex II 1 G Ex ia IIB T6 Ga}$ with intrinsically safe supply units, whole sensor zone 0
CLS-23XiT-11, 12, 20, 21	High temperature performance for explosive areas, $\text{Ex II 1/2 G Ex ia IIB T6 Ga/Gb}$ with intrinsically safe supply units, electrode part zone 0, housing zone 1

## INSTALLATION AND RECOMMENDATIONS

For top mounting (vertical position) it is necessary to keep the distances from walls and from other sensors.

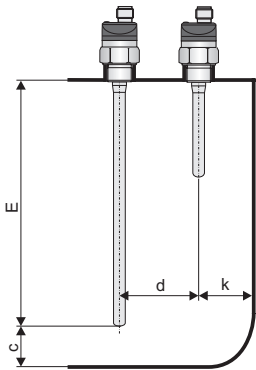

$$c \geq 10 + \frac{E}{50}$$

$$d \geq 40 + \frac{E}{40}$$

$$k \geq 20 + \frac{E}{20}$$

*E* – Electrode length in mm

Applies to:

All variants

When installing the sensor into the **pipe** it is necessary to choose properly internal diameter of the tube to ensure the inner walls distances from the electrode to **min. 5 mm**. In some cases (sticky liquids, liquids with low dielectric constant) is suitable to mount the sensor in the **knee tube**.

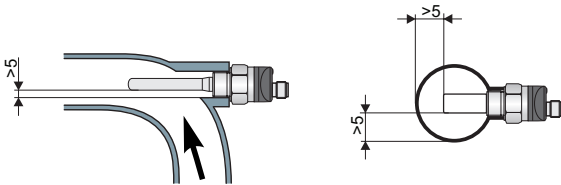

Applies to:

CLS-23\_-10, 11, 12, 20, 21

Sensor installation **close to inlet hole**, in a narrow neck or using improper welding flange may result in **malfunction** of the sensor.

Suitable welding flanges can be found in the Dinel assortment, types ON, NN – see Accessories.

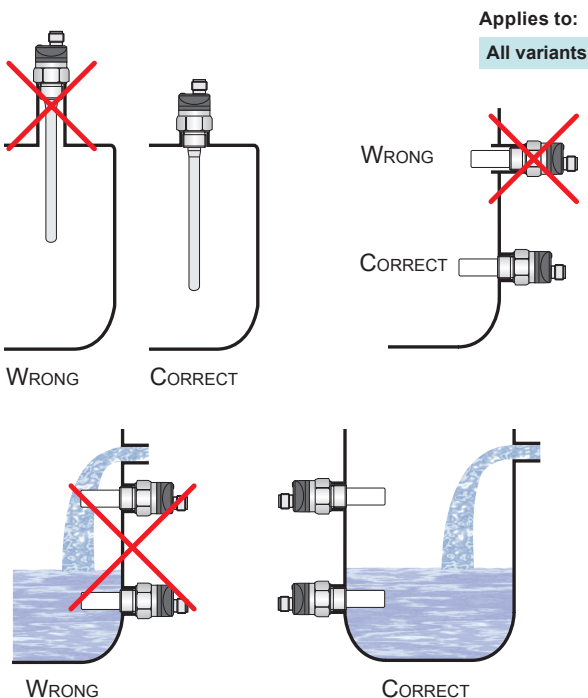

Applies to:

All variants

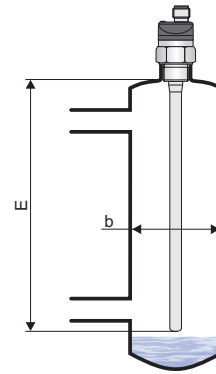

Installation into the auxiliary stilling pipe. We recommend to keep the tube diameter.

$$b \geq 40 + \frac{E}{20}$$

*E* – Electrode length in mm

Applies to:

CLS-23\_-20, 21, 30

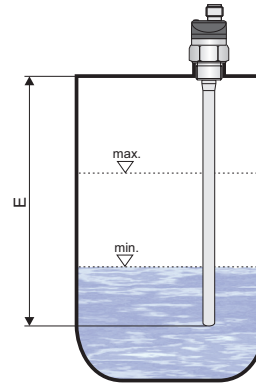

When installing the sensor in vertical position it can be used for **2-state (LO-HI) level control** between the min. and max. level. The position of the minimum and maximum level can be changed by setting the sensor. Fluid changes require new settings of the sensor

*E* – Electrode length in mm

Applies to:

CLS-23\_-20, 30 (only for electrically non-conductive liquids)

CLS-23\_-21 (for electrically conductive liquids)

For electrodes with a length **over 300 mm** for the detection in non-conductive containers (sensors in vertical position) must be used the **auxiliary electrode** (e.g. conductivity probe). The auxiliary electrode is connected to the sensor housing. Recommended length of the auxiliary electrode and the distance from the sensor are shown in the picture. Suitable types of auxiliary electrode probes are e.g. Dinel CNP-18F-30 with M18 thread.

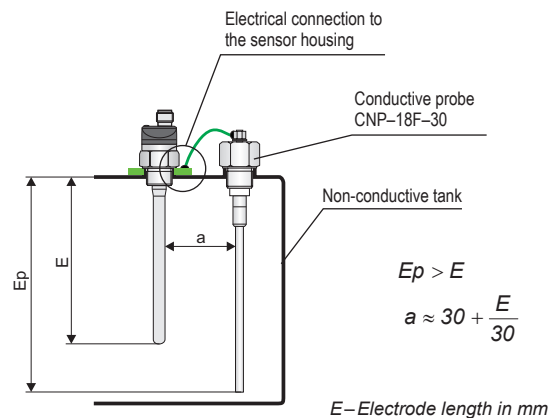

$$E_p > E$$

$$a \approx 30 + \frac{E}{30}$$

*E* – Electrode length in mm

Applies to:

CLS-23\_-20, 21, 30 (for electrode length up to 300 mm)

## SENSOR SETTINGS

The setting is done by placing magnetic pen MP-8 to sensitive spot (M) located on the front of the sensor. Short time attaching (up to 2 sec.) of the magnetic pen to the sensitive spot (M) makes the sensor open. Long time attaching (at least 4 sec.) of the pen when the level is changed, defines closed state of the sensor. In this way is set the sensitivity for the measured medium and switching modes SO (normally open) or SC (normally closed).

For detailed information please read at the instructions manual.

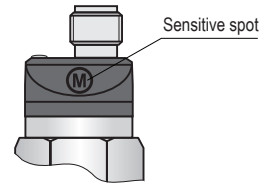

### FACTORY DEFAULT SETTINGS:

Types **CLS-23\_-10; -20; -30** are set to detect mineral oil, **CLS-23\_-11; -12; -21** to detect water.

## ELECTRICAL CONNECTION

CLS-23\_-\_-\_-S-\_-

Positive pole (+U) of power supply is connected through a load (relay) to brown (blue) wire or pin connector No. 1, negative pole is connected to white wire or pin connector No. 3.

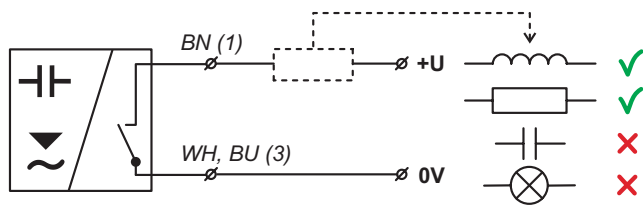

Fig. 1: S type sensors connection (electronic switch)

CLS-23\_-\_-\_-P-\_-

Positive pole (+U) of power supply is connected to brown wire or pin connector No. 1, negative pole is connected to blue wire or pin connector No. 3. Load (relay) is connected to black wire or pin connector No. 4.

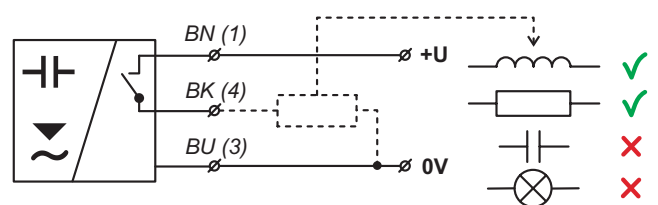

Fig. 2: PNP type sensors connection

CLS-23\_-\_-\_-R-\_-

Brown wire or pin connector No. 1 is connected to positive pole (+U) of Intrinsically safe supply unit. Blue wire or pin connector No. 3 is connected to negative pole of Intrinsically safe supply unit.

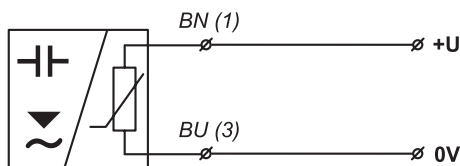

Fig. 3: NAMUR type sensors connection

Legend:

- (1...3) – Terminals number for variants with connector
- BN – Brown
- WH – White
- BK – Black
- BU – Blue





Note:

The sensor output is protected against short circuits. Capacity loads and loads with low sleep resistance (bulb) the sensor evaluates as a short circuit. In case of high ambient electromagnetic interference, parallel conductors with power lines, or lines at distances greater than 30 m, we recommend to use shielded cable.



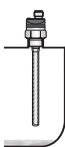

## STATUS SIGNALIZATION (only with LED state indicator variant)

Indicator	Function
Orange LED	<b>Continuous light</b> – Sensor is closed (switched ON) <b>Dark</b> – Sensor is open (switched OFF) <b>Rapid flashing (period 0.2 s)</b> – Unrecognized upper and lower limits or setting mistake <b>Slow flashing (period 0.8 s)</b> – Short circuit at sensor output

Sensor for each flash of the LED switches its output on for approx. 3 ms. This period is sufficiently short to avoid unwanted switching of relay contacts. For binary inputs, we recommend to set the filter so as not to respond to pulses shorter than 3 ms.

Level state	Mode	Output state	LED indicator*
	O	<b>CLOSED</b> NAMUR: higher current	 (Shine)
	O	<b>OPEN</b> NAMUR: lower current	 (Dark)

\* Variant "E" without LED state indicator

Level state	Mode	Output state	LED indicator*
	C	<b>CLOSED</b> NAMUR: higher current	 (Shine)
	C	<b>OPEN</b> NAMUR: lower current	 (Dark)

\* Variant "E" without LED state indicator

For **security reasons**, we recommend to set the **mode SO** (normally open, sensor closes when immersed) for **minimum level** detection. Any failure of the sensor or wiring is equally apparent as the emergency level state. Analogously – for the **maximum level** detection is recommended to set the **mode SC** (normally closed, sensor opens when immersed).

## RANGE OF APPLICATION

Detection of various types of liquids – water, oils, coolants, water solutions, etc. Suitable for metal vessels, containers, tanks, sumps, pipes. Suitability for non-metallic containers (glass, plastic containers, etc.) please consult with the manufacturer.

## ORDER CODE

CLS-23  -  -  -  -  E  Cable  — Length of cable in meters (variant "A")



Electrode length in mm

Process connection: **G3/8** – Pipe thread G 3/8"  
**G1/2** – Pipe thread G 1/2"  
**M18** – Metric thread M 18x1,5  
**M20** – Metric thread M 20x1,5  
**NPT** – Sealing thread 1/2–14 NPT

Output type: **P** – PNP (Open collector)  
**S** – 2-wire electronic switch  
**R** – NAMUR (For Xi variants only)

Electric connection: **A** – Cable outlet (+ Spec. the length of the cable)  
**C** – Connector (+ Spec. type of the socket) except variant "E"

Performance: \_\_\_\_\_ Type and electrode performance:

**N** – Normal for non-explosive areas  
**E** – Extended temperature range variants for non-explosive areas (without LED)  
**NT** – High temperature variants for non-explosive areas  
**Xi** –  (intrinsically safe) for hazardous areas  
**XiT** –  (intrinsically safe), high temperature variants

**10** – Uncoated short bar, length 30 mm  
**11** – Insulated (coated) short bar (PP), length 30 mm  
**12** – Insulated (coated) short bar (FEP), length 30 mm  
**20** – Partly insulated rod (FEP), length 50 ... 1000 mm  
**21** – Fully insulated rod (FEP), length 50 ... 1000 mm  
**30** – Uncoated removable rod, length 50 ... 1000 mm

## CORRECT SPECIFICATION EXAMPLES

CLS-23N-10-A-S-G3/8 cable 5 m

(N) For non-explosive areas; (10) Uncoated short bar electrode 30 mm, (A) Cable outlet with 5 m fixed cable; (S) 2-wire electronic switch; (G3/8) Process connection with pipe thread G3/8"

CLS-23E-30-A-S-G1/2 E450 cable 10 m

(E) Extended temperature range performance for non-explosive areas; (30) Uncoated removable rod electrode; (A) Cable outlet with 10 m fixed cable; (S) 2-wire electronic switch; (G1/2) Process connection with pipe thread G1/2"; (E450) Electrode length 450 mm.

CLS-23NT-20-C-S-M18 E320

(NT) High temperature variants for non-explosive areas; (20) Partly insulated rod electrode (FEP); (C) Electrically connection with connector; (S) 2-wire electronic switch; (M18) Process connection with metric thread M18x1.5; (E320) Electrode length 320 mm.

CLS-23Xi-11-C-R-NPT

(Xi) Intrinsically safe for hazardous areas; (11) Insulated (coated) short bar (PP) electrode 30 mm (C) Electrically connection with connector; (R) NAMUR output type; (NPT) Process connection with sealing thread 1/2 – 14 NPT.

---

## ACCESSORIES

### Standard

(included in the level sensors price)

- 1pc of Magnetic pen MP-8
- 1pc of Seal (Klingerit)

### Optional

(for extra charge)

- Extra cables (over the standard length 2 m)
- Non-rewirable connector plug M12 ("N" and "NT" variants)
- Rewirable connector plug M12 ("N" and "NT" variants)
- Steel or Stainless steel welding flange
- Other seals (PTFE, Al, etc.)

---

## SAFETY, PROTECTIONS, COMPATIBILITY AND EXPLOSION PROOF

The level sensor is equipped with a protection against electric shock on electrode, polarity, overvoltage and short-term current overload on the output.

Electromagnetic compatibility is provided by conformity with standards EN 55011/B, EN 61326-1, EN 61000-4-2 (8 kV), -4-3 (10 V/m), -4-4 (2 kV), -4-5 (1 kV) and -4-6 (10 V).

Explosion proof CLS-23Xi and XiT is examined by FTZÚ - AO210 Ostrava - Radvanice, certificate No. FTZÚ 12 ATEX 0106X.

Version 12/2012

CLS-23-dat-8.8



QMS  
ISO 9001

**Dinel, s.r.o.**  
U Tescomy 249  
760 01 Zlín, Czech Republic

Phone: +420 577 002 003  
Fax: +420 577 002 007

sale@dinel.cz  
www.dinel.cz