

- For limit level sensing of liquid, and bulk-solid and powder materials
- Xi version for usage in explosive areas
- Direct mounting into various containers, silos, vessels, tanks, filling inlets, reservoirs, etc.
- Sensitivity and hysteresis fluently adjustable
- NPN, PNP, NAMUR output (EN 60947-5-6)
- Material of housing and electrode from stainless steel



Capacitive level sensors (switches) DLS® are designed for limit level sensing of liquids, bulky solid and powder materials in vessels, containers, silos, tanks, reservoirs, etc. Sensors are made in several modifications of sensing electrodes – short and long rods or rope. The electrodes can be coated what has important sense in case of adhesive, aggressive or electrically conductive media sensing. The process coupling at the housing can be with thread M27x2, M30x1.5, G3/4" or with Tri-clamp coupling. Electric connection is provided by means of permanent cable lead (variant B) or by means of connector (variant C). Output performances – transistor outputs with open collector (NPN, PNP) or NAMUR output.

There are next performances available: **N** – For normal atmospheres; **Xd** – For use in flammable dust atmospheres; **Xi** – Explosion proof – intrinsically safe for hazardous (explosive) areas; **XiM** – Explosion proof – intrinsically safe for use in mines with methane or flammable dust presence danger (see technical specifications).

FEATURES OF VARIANTS

- | | |
|-------------------|--|
| DLS-27_-10 | Uncoated short bar electrode for sensing non-adhesive bulk-solid (powder) materials (sand, sugar) and electrically non-conductive liquids (oils, diesel, petrol), horizontal mounting.
Electrode length 50 mm or 100 mm. |
| DLS-27_-11 | Fully coated short bar electrode for sensing electrically conductive liquids (water). Assembly into a side wall of vessel or into a pipe.
Electrode length 30 mm. |
| DLS-27_-20 | Semi-coated rod electrode for sensing light-bulk solid or powder materials (plastic granulates, flour, cement) and non-conductive liquids (plant oils), horizontal, slant or vertical mounting.
Electrode length from 0.1 m to 1 m. |
| DLS-27_-21 | Fully (FEP) coated rod electrode for sensing electrically conductive liquids (water solutions, water), adhesive and aggressive materials, horizontal or vertical mounting.
Electrode length from 0.1 m to 1 m. |
| DLS-27_-22 | Fully (PFA) coated rod electrode for sensing electrically conductive liquids (water solutions, water), adhesive and aggressive materials, horizontal or vertical mounting.
Electrode length from 0.1 m to 1 m. |
| DLS-27_-30 | Dismountable rod uncoated electrode for sensing bulk-solid (powder) materials and conductive or non-conductive liquids. Mounting from the top (vertically) or slant from the side.
Electrode length from 0.1 m to 3 m. |
| DLS-27_-31 | Fully coated rod electrode for sensing aggressive electrically conductive liquids (water, solutions of chemicals), vertical mounting.
Electrode length from 0.1 m to 2 m. |
| DLS-27_-40 | Uncoated stainless steel rope electrode and weight for general purpose in deeper silos (bulk-solid and powder materials sensing – sand, gravel, cement) or hoppers (liquids sensing), vertical mounting.
Electrode length from 1 m to 6 m. |

DIMENSIONS DRAWINGS

DLS-27_-10

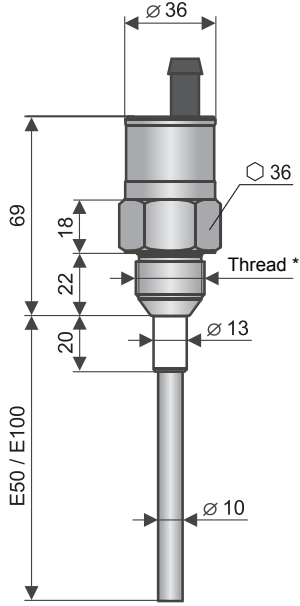

DLS-27_-11

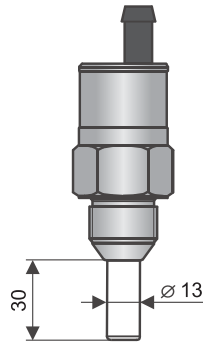

DLS-27_-20

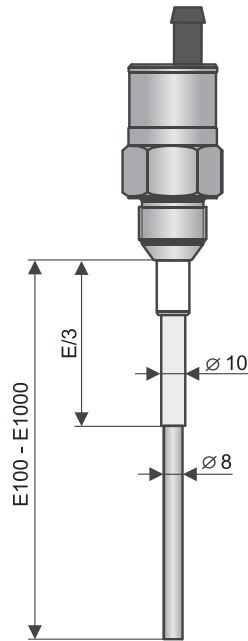

DLS-27_-21, 22

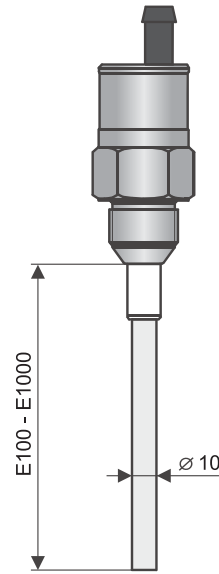

DLS-27_-30

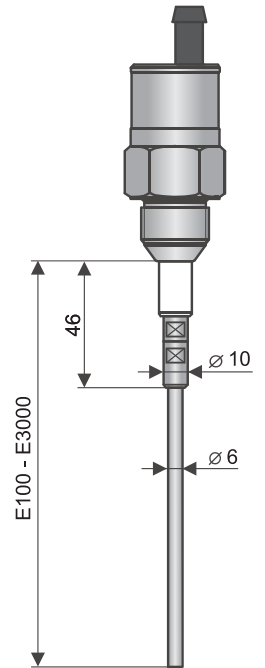

* Type of threads: G 3/4" ; M27x2 ; M30x1.5

DLS-27_-31

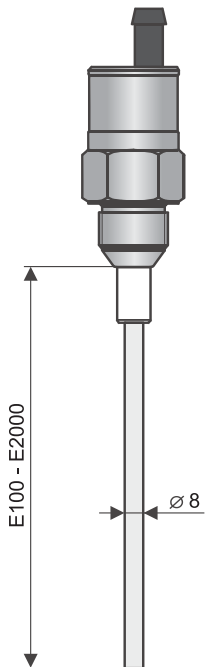

DLS-27_-40

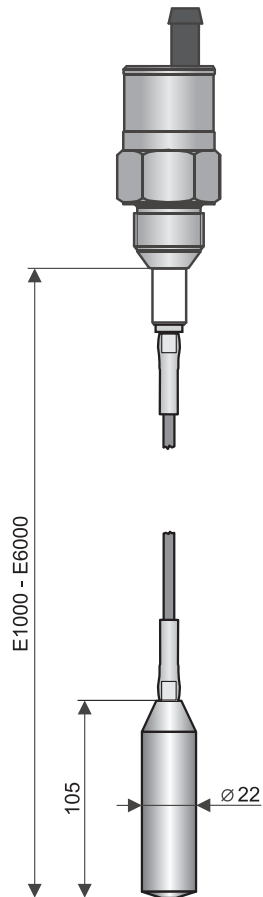

High temperatures variants

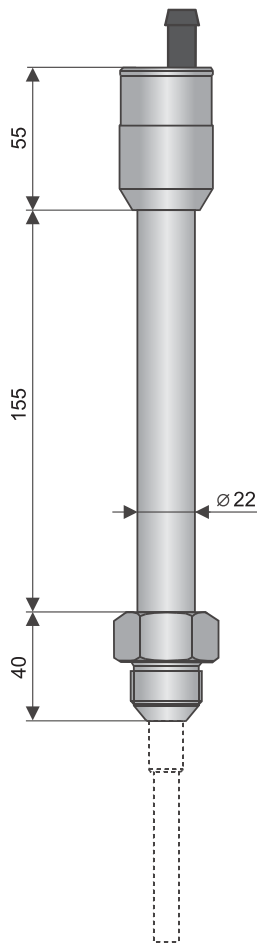

Tri-clamp

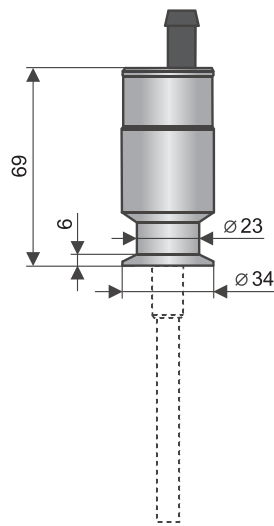

Variants "C" with connector

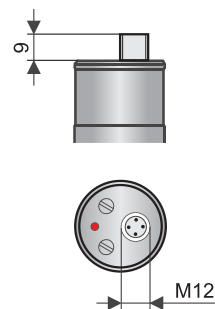

Variants "B" with cable outlets

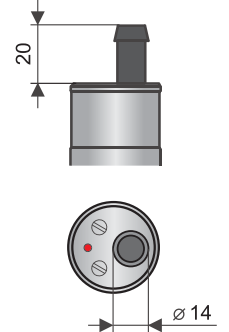

Variants "D" with cable outlets

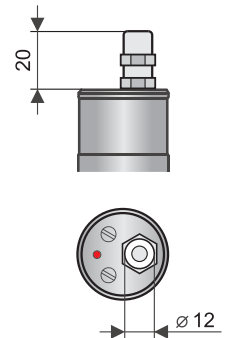

TECHNICAL SPECIFICATIONS

Supply voltage	7 ... 36 V DC *	
Current supply (state OFF / ON)	3 / 10 mA *	
Switching current (NPN, PNP output)	200 mA *	
Remanent voltage – ON state	Max. 1.5 V	
Output time delay	0.2 s	
Input resistance / Electric strength	1 MΩ / 1 kV AC	
Coupling capacity / Electric strength	47 nF / 250 V AC *	
Protection class	IP67	
Cable (version with cable outlets)	PVC 3x0.5 mm ² or 2x0.75 mm ²	
Weight (excl. electrode, with 2 m cable)	DLS–27_ DLS–27_T	Approx. 0.4 kg Approx. 0.7 kg

* Only for variants "N" and "Xd"

ELECTRICAL PARAMETERS – variants Xi, XiT, XiM

Supply voltage	8 ... 9V DC
Current supply (state OFF / ON) – NAMUR	≤ 1 mA / ≥ 2.2 mA
Max. internal values	U _i =12 V DC; I _i =15 mA; P _i =45 mW; C _i =60 nF; L _i =10 μH
Coupling capacity / Electric strength	2.7 nF / 500 V AC

USED MATERIALS

Part of the DLS	Type	Standard material	Optional (on request)
Housing	All type	St. Steel W. Nr. 1.4301 (AISI 304)	St. Steel W. Nr. 1.4571 (AISI 316 Ti)
Insulating bushing	All type	PTFE	–
Electrode coating	DLS–27_–11	PTFE	–
Electrode coating	DLS–27_–20, 21, 31	FEP	–
Electrode coating	DLS–27_–22	PFA	–

TEMPERATURE AND PRESSURE DURABILITY

Variant / Performance	Mounting	Temp. t _p	Temp. t _m	Temp. t _a	Max. operating pressure for t _p temperature				
					to 30°C	to 85°C	to 120°C	to 150°C	to 180°C
DLS–27N–10, 11, 20, 30	Horizontal	-25 ... +85°C	-25 ... +85°C	-20 ... +80°C	3 MPa	2 MPa	–	–	–
DLS–27N–20, 21, 22, 30, 31, 40	Vertical	-25 ... +85°C	-40 ... +150°C	-20 ... +80°C	3 MPa	2 MPa	–	–	–
DLS–27NT–10, 11, 20, 30	All	-40 ... +200°C	-40 ... +200°C	-20 ... +75°C	3 MPa	2 MPa	0.5 MPa	0.3 MPa	0.1 MPa
DLS–27NT–21, 22, 31, 40	Vertical	-40 ... +180°C	-40 ... +180°C	-20 ... +75°C	3 MPa	2 MPa	0.5 MPa	0.3 MPa	0.1 MPa
DLS–27Xd	All	-20 ... +70°C	-20 ... +70°C	-20 ... +70°C	3 MPa	2 MPa	–	–	–
DLS–27Xi, XiM	All	-20 ... +85°C	-20 ... +85°C	-20 ... +75°C	–	–	–	–	–
DLS–27XiT, XiMT–10, 11, 20, 30	All	-40 ... +200°C	-30 ... +200°C	-20 ... +75°C	3 MPa	2 MPa	0.5 MPa	0.3 MPa	0.1 MPa
DLS–27XiT, XiMT–21, 22, 31, 40	Vertical	-40 ... +180°C	-30 ... +120°C	-20 ... +75°C	3 MPa	2 MPa	0.5 MPa	0.3 MPa	0.1 MPa
DLS–27Xi/XiT/XiM – zone 0	All	–	-20 ... +60°C	-20 ... +60°C	0.08... 0.11 MPa to 30°C				

PROCESS CONNECTION

Type	Size	Marking
Pipe thread	G 3/4"	G
Metric thread	M27x2	M27
Metric thread	M30x1.5	M30
Tri-clamp (standards DN 20)	–	Cl

TYPE OF OUTPUT

Output	Variants
NPN ("NC", "NO")	N, NT, Xd
PNP ("PC", "PO")	N, NT, Xd
NAMUR ("RC", "RO")	Xi, XiM, XiT, XiMT

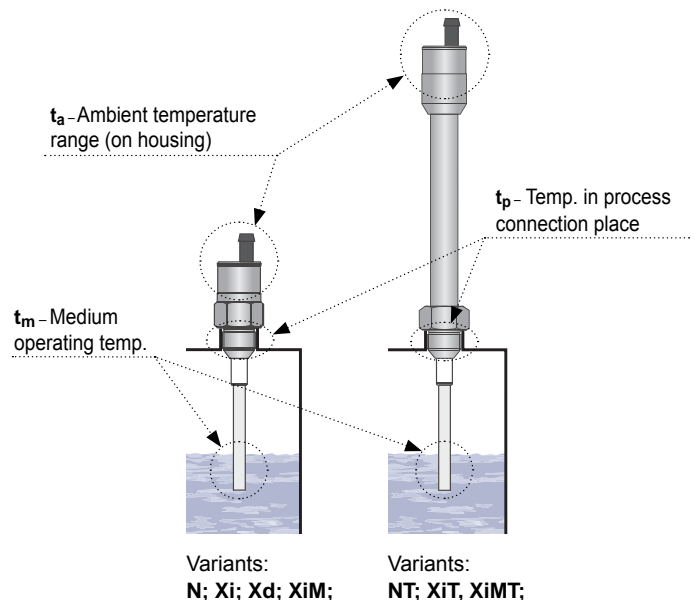

WORKING AREAS (EN 60079-10, 14 and EN 50281-1-2)

DLS-27N	Performance for non-explosive areas.
DLS-27NT	High temperature performance for non-explosive areas.
DLS-27Xd	Performance for flammable dust areas, Ⓜ II 1D Ex tD A20 T77°C IP6X, whole sensor zone 20, 21 and 22.
DLS-27Xi	Performance for explosive areas, Ⓜ II 1 G Ex ia IIB T6 Ga; Ⓜ II 1 D Ex ia IIIC T76°C Da with intrinsically safe supply units, whole sensor zone 0 and 20.
DLS-27XiT	High temperature performance for explosive areas, Ⓜ II 1/2 G Ex ia IIB T6 Ga/Gb; Ⓜ II 1/2 D Ex ia IIIC T76°C Da/Db with intrinsically safe supply units, electrode part zone 0 and 20, housing zone 1 and 21.
DLS-27XiM	Intrinsically safe explosion-proof performance for use in mines, Ⓜ I M2 Ex ia I Mb with intrinsically safe supply units.
DLS-27XiMT	High temperature intrinsically safe explosion-proof performance for use in mines, Ⓜ I M2 Ex ia I Mb with intrinsically safe supply units.

MOUNTING RECOMMENDATION

In the case of **vertical mounting** it is recommended to keep the mentioned distances applied to the length of the electrode (the longer one).

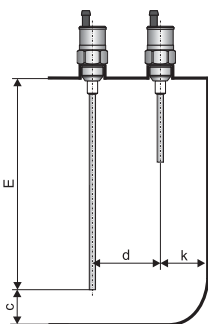

$$c \geq 10 + \frac{E}{50}$$

$$d \geq 40 + \frac{E}{40}$$

$$k \geq 20 + \frac{E}{20}$$

E - Electrode length in mm

Applies to:
All vertically mounted sensors

In the case of **side wall mounting** it is necessary to place the sensor aside the falling material (liquid or solid).

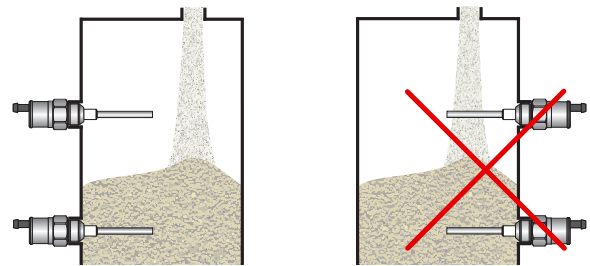

Applies to:
All from side mounted sensors

In the case of **side wall mounting** it is necessary to avoid long fitting tubes, where could the rests of sensed media cumulate - see the right figure. We recommend to mount the sensor so that the whole sensing electrode is inside the container (vessel).

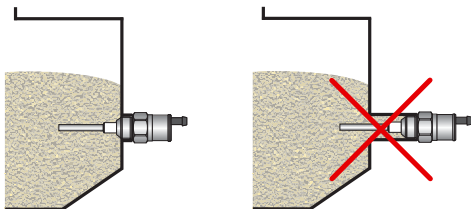

Applies to:
All from side mounted sensors

In the case of **vertical mounting** it is necessary to avoid long fitting tubes, where could the vapours condense or some rests sediment. Right figure wrong, left figure appropriate. The similar situation is when the sensing electrode goes through the concrete ceiling of the silo. The hole diameter should be at least 50 mm (acc. to the thickness of the ceiling).

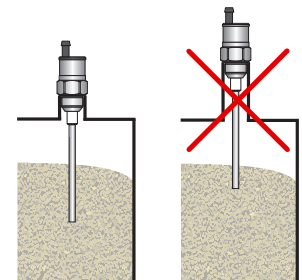

Applies to:
All vertically mounted sensors

In the case of **slant wall mounting** it is necessary to eliminate long fittings and reduce the media sedimentation. The wrong example is in the middle figure. Left figure - appropriate mounting on the auxiliary vertical plate. In some cases is allowed the variant shown on the right figure - but only for DLS-27_-10 type, and only for not blocking materials.

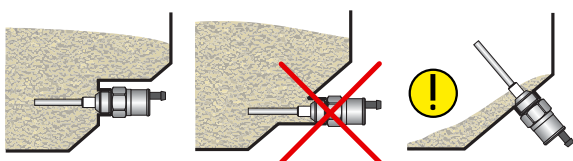

Applies to:
DLS-27_-10, 20

$$h = 50 \div 200 \text{ mm}$$

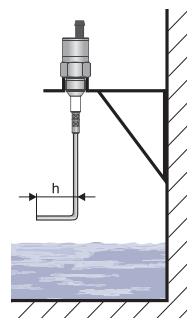

In the case of **vertical installation** for non-conductive fluids sensing is useful to bend the end of electrode to right angle. We can gain by it the good sensitivity at the end of electrode for various fluids. When the supposed media is water the bending has no sense (the sensor react just when the level touches the end of electrode). When the environmental conditions (wind, rain, snow) are present, we recommend to use types with insulated electrode.

Applies to:
DLS-27_-30

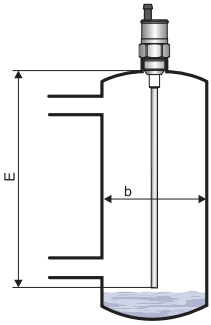

Mounting in a **bypass measuring tube**. We recommend to keep the tube diameter.

$$b \geq 40 + \frac{E}{20}$$

E – Electrode length in mm

Applies to:

DLS-27_-20, 21, 22, 30, 31

Protective roof mounting is recommended when vertical movement of material could damage the sensing electrode (abrasive materials, blocks creating solid materials, etc.)

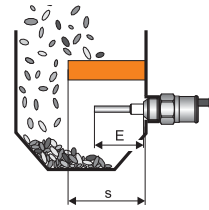

E – Electrode length in mm

$$s \approx \frac{4}{3}E \quad p \approx \frac{3}{4}E$$

$$m \approx \frac{2}{3}E$$

Applies to:

DLS-27_-10, 20

In the case of mounting in the **pipe** it is necessary to provide the minimum distance of the inner walls from the electrode at 5 mm. In some cases (sticky fluids, low permittivity liquids) it is better to mount the sensor to pipe bend.

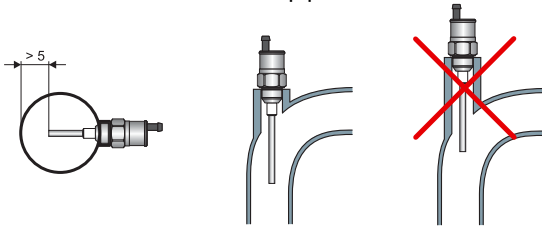

Applies to:

DLS-27_-10, 11, 21, 22

In the case of vertical mounting it is possible to use hysteresis setting for simple **two state regulation** (pump control). The height of the controlled level is done by sensitivity setting, the gap between the min. and max. is defined by hysteresis.

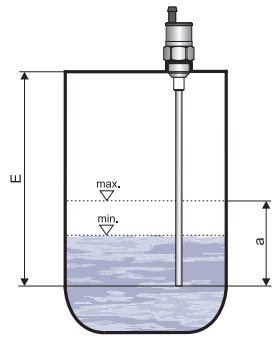

$$a \approx \frac{1}{10}E \div \frac{1}{3}E$$

E – Electrode length in mm

Applies to:

DLS-27_-20, 21, 22, 31

In the case of **vertical mounting** in outer areas or in the case of high mechanical exertion we recommend to install protective hose on the cable (see figure).

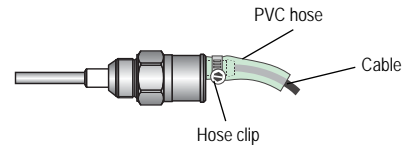

ELECTRICAL CONNECTION

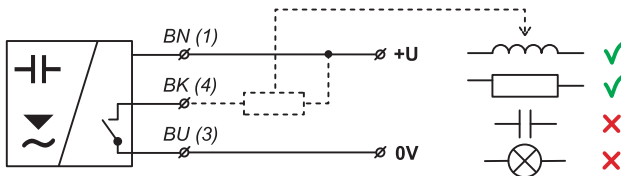

NPN type sensors connection
(version N; NT; Xd)

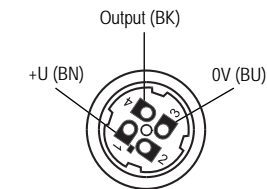

Inside of the connector socket
(Variant "C")

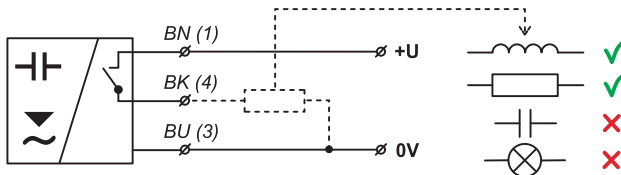

PNP type sensors connection
(version N; NT; Xd)

Legend:

- (1...) – Numbers of terminals inside of the connector
- BN – Brown
- BU – Blue
- BK – Black

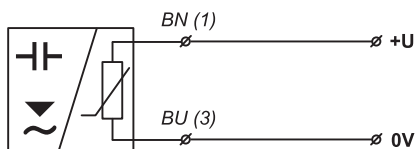

NAMUR type sensors connection
(version Xi; XiT; XiM; XiMT)

Sensor with NPN or PNP output is allowed to lead only by resistive or inductive load. Positive supply voltage (+U) is connected to the brown conductor BN (1), negative (0V) to the blue conductor BU (3) and the leads (only NPN or PNP type of output) to the black conductor BK (4). The capacity loads and low resistance loads (bulb) is evaluated by the sensor as short circuit.

Version "Xd" is manufacture only with fixing cable (variants "D" with cable outlets). The end of this cable must be in terminal box with protection class IP6x.

Note: In case of strong ambient electromagnetic interference, paralleling of conductors with power distribution, or for the distribution to distance over 30 m, we recommend to use shielded cable.

RANGE OF APPLICATION AND INSTALLATION OF MAIN VARIANTS

DLS-27_-10

Is produced in two versions - with 50 mm or 100 mm length electrode. Short version (E50) is suitable for clean non-conductive liquids level sensing (oils, diesel, petrol, etc.). Longer version (E100) is designed for non-adhesive bulk-solid or non-adhesive powder materials (plastic granulates, sand, sugar, grains, etc.) and other non-conductive liquids (lubricants, plant oils). Sensor is specified to be mounted directly into a vessel or container wall (horizontal position) by means of welding flange or stainless steel fixing nut. In case of level sensing of low-permittivity media in non-conductive containers it is recommended to mount the sensor on auxiliary metal-plate electrode with min. 200 cm² area.

DLS-27_-11

Is specified for limit level sensing of electrically non-adhesive conductive liquids (water and water solutions). It is possible to use it for detection of boundary between different permittivity liquids (e.g. water - oil). Sensor is mounted directly into the side wall of the vessel or in a pipe (horizontal position) by means of normal or stainless steel welding flange.

DLS-27_-20

Is designed for limit level detection of light-bulk solid materials (plastic granulates) or powder materials (flour, cement, limestone powder, detergents, etc.) and for materials with variable humidity (feeding mixtures, wood sawdust, etc.). It is possible to use it for non-conductive fluids with up to 2% of water (plant oils, liquid propane, etc.). The sensor with electrode longer than 300 mm is recommended to mount in vertical position only. Sensor is mounted directly into a vessel or container wall in horizontal (up to E300), slant or vertical position by means of welding flange or stainless steel fixing nut. We should minimize the hollow spaces between the electrode and the wall where the material can sediment (see application notes). In case of level sensing in non-conductive containers it is recommended to mount the sensor on auxiliary metal plate electrode with min. 400 cm² area.

DLS-27_-21, 22

Is specified for conductive liquids level sensing (water, water solutions, mud, etc.). It is designed for horizontal (up to E300) or vertical installation directly in the wall of a vessel. It reacts on partial or full immersion of the electrode (dependent on adjusted sensitivity). The less is the sensitivity the better is resistance to an adhered rests of media. Sensor is mountable directly into wall of a vessel in horizontal or vertical position by means of welding flange. DLS-27_-22 type is more resistant to aggressive liquids.

DLS-27_-30

Is designed for universal use in vertical position for limit level detection of liquids (conductive and non-conductive) and bulk-solid and powder materials. It is not recommended to install the sensor into closed vessels where intensive condensation occurs. Electrically conductive liquids are sensed just by touch of the end of electrode. To react to non-conductive liquid or solid material it is necessary 5 ÷ 20% dip into a medium dependently on the permittivity of sensed medium and set sensitivity. Sensor is mounted directly into a tank, vessel, container or basin in slant or vertical position by means of welding flange or stainless steel fixing nut. In case of level sensing of low-permittivity media in non-conductive containers it is recommended to mount the sensor on auxiliary metal-plate electrode with min. 500 cm² area.

DLS-27_-31

Is designed for limit level detection of conductive liquids (water and solutions of chemicals). It is possible to install the sensor into closed vessels, tanks, basins, etc. The sensor reacts to liquid level after 2 ÷ 20% dip into a liquid dependently on the permittivity of sensed medium and set sensitivity. Sensor is mounted directly into a vessel, tank or open basins in vertical position by means of welding flange or fixing nut. When installed into an open basin it is necessary to ground the housing of sensor or to connect it with sensed liquid. For this purpose it is possible to use any metallic ever immersed object (pipe, etc.).

DLS-27_-40

Is specified for versatile use for limit level detection of liquids (conductive and non-conductive) and bulk-solid and powder materials in depths down to 6 m. It is not recommended to install the sensor into closed vessels where intensive condensation occurs. Electrically conductive liquids are sensed just by touch of the end of electrode. To react to non-conductive liquid or solid material it is necessary 5 ÷ 20% immersion into a material. Sensor is mounted directly into a vessel, tank or open basins in vertical position by means of welding flange or fixing nut. When installed into an open basin it is necessary to ground the housing of sensor or to connect it with sensed liquid. For this purpose it is possible to use any metallic ever immersed object (pipe, etc.).

SENSOR SETTING

The sensor is factory adjusted for basic sensitivity. The sensitivity is set by trimmer located under the left cover screw on the rear side. Clockwise turning makes the sensitivity lower, reverse direction turning makes the sensitivity higher. The hysteresis is set by trimmer located under the right cover screw. Clockwise turning makes the hysteresis higher, reverse direction turning makes it lower. The lower the hysteresis is, the higher sensitivity is possible to obtain, but the resistance against various disturbances get worse.

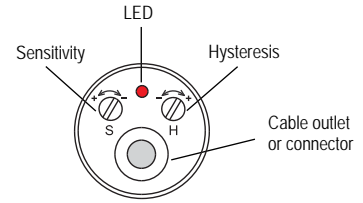

Top view of level sensor

For detailed information please read at the instructions manual.

STATUS SIGNALIZATION

	Level state	Type of output	Output state	LED
Minimum level sensing		DLS-27N_ _ _ _ -NO_ _ DLS-27Xd_ _ _ _ -D-NO_ _ DLS-27N_ _ _ _ -PO_ _ DLS-27Xd_ _ _ _ -D-PO_ _	CLOSED	 (Shine)
		DLS-27Xi_ _ _ _ -RO_ _	HIGHER CURRENT	
		DLS-27N_ _ _ _ -NO_ _ DLS-27Xd_ _ _ _ -D-NO_ _ DLS-27N_ _ _ _ -PO_ _ DLS-27Xd_ _ _ _ -D-PO_ _	OPEN	 (Dark)
		DLS-27Xi_ _ _ _ -RO_ _	LOWER CURRENT	
Maximum level sensing		DLS-27N_ _ _ _ -NC_ _ DLS-27Xd_ _ _ _ -D-NC_ _ DLS-27N_ _ _ _ -PC_ _ DLS-27Xd_ _ _ _ -D-PC_ _	CLOSED	 (Shine)
		DLS-27Xi_ _ _ _ -RC_ _	HIGHER CURRENT	
		DLS-27N_ _ _ _ -NC_ _ DLS-27Xd_ _ _ _ -D-NC_ _ DLS-27N_ _ _ _ -PC_ _ DLS-27Xd_ _ _ _ -D-PC_ _	OPEN	 (Dark)
		DLS-27Xi_ _ _ _ -RC_ _	LOWER CURRENT	

Notes: For minimum level sensing we recommend sensor with normally open output – NO, PO, RO. It is for failure safety reasons – eventual failure of sensor behaves similarly as an exceeding of the limit state. Analogically for maximum level sensing we recommend normally closed outputs – NC, PC, RC.

ACCESSORIES

Standard (included in the level sensors price)

- 1 pcs. Seal (asbestos free)
- 1 pcs. Screwdriver for adjustment (each 5 pcs.)

Optional (for extra charge)

- Extra cables (over the standard length 2m)
- Connector plug (type ELWIKa or ELKA)
- Normal steel welding flange
- Stainless steel welding flange
- Stainless steel fixing nut
- Other seals (PTFE, AI, etc.)

ORDER CODE

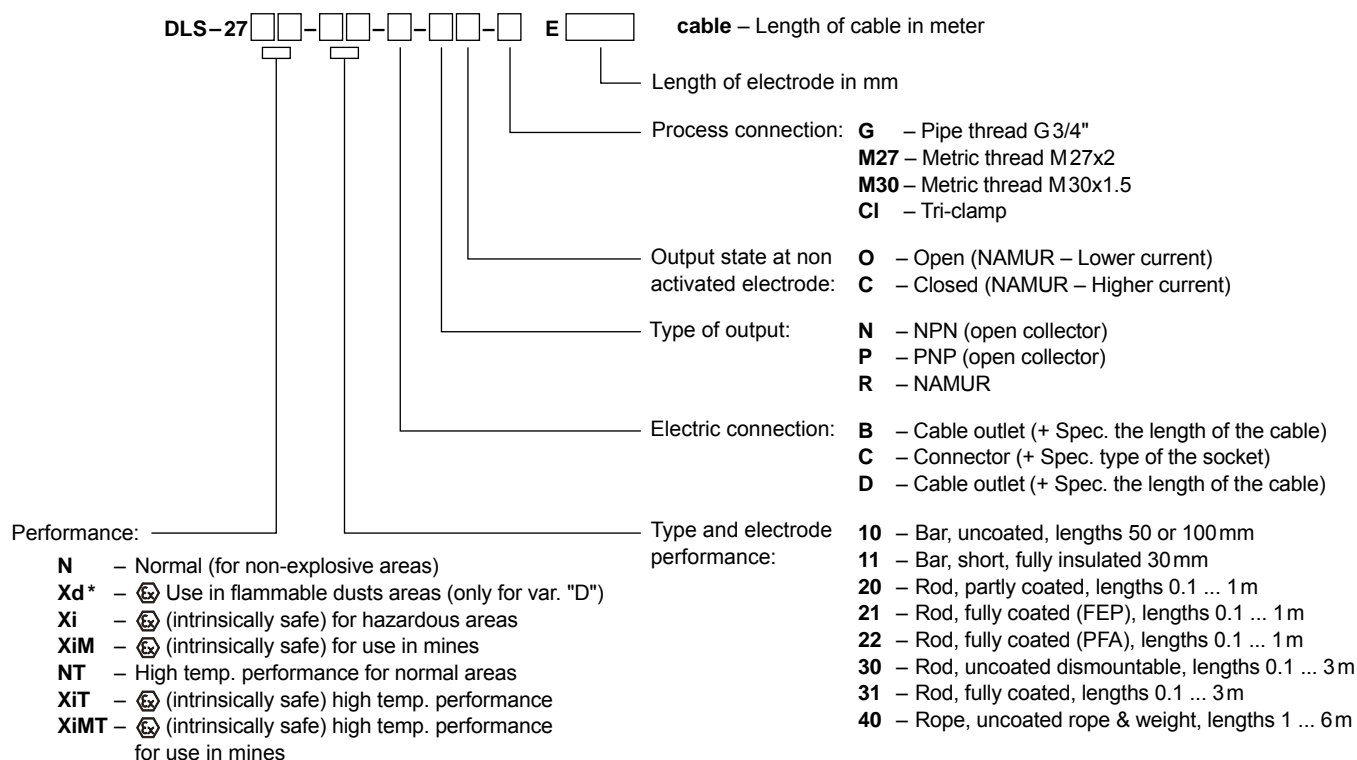

* Only for variants "D" (electric connection with cable outlet)

CORRECT SPECIFICATION EXAMPLES

DLS-27N-10-B-NO-M27 E100 cable 5m

(N) Normal performance; (10) Uncoated bar electrode; (B) Cable outlet with 5 m length cable; (NO) Output type NPN with open state at non-activated electrode; (M27) Metric thread M27x2 process connection; (E100) Electrode length 100mm

DLS-27NT-21-C-PC-G E580

(NT) Normal high temperature performance; (21) Fully coated rod electrode (FEP); (C) Connector; (PC) Output type NPN with closed state at non-activated electrode; (G) Pipe thread G3/4" process connection; (E580) Electrode length 580 mm.

DLS-27Xi-30-C-RO-M30 E1420

(Xi) Explosion-proof performance; (30) Dismountable uncoated electrode; (C) Connector, (RO) Output type NAMUR with lower current at non-activated electrode; (M30) Metric thread M30x1,5 process connection; (E1420) Electrode length 1420 mm.

DLS-27Xd-20-D-NC-G E430 cable 3m

(Xd) Flammable dust areas performance; (20) Partly coated electrode; (D) Cable outlet; (NC) Output type PNP with closed state at non-activated electrode; (M30) Metric thread M30x1,5 process connection; (E430) Electrode length 430 mm.

SAFETY, PROTECTIONS, COMPATIBILITY AND EXPLOSION PROOF

Level sensor DLS-27 is equipped with protection against electric shock on electrode, reverse polarity, output current overload, short circuit and short time over voltages.

Electromagnetic compatibility is provided by conformity with standards EN 55022/B, EN 61326-1, EN 61000-4-2, -3, -4, -5 and -6. Explosion proof DLS-27Xi, XiM and Xd is examined by FTZÚ - AO210 Ostrava - Radvanice, certificate No. FTZÚ 02 ATEX 0234X and FTZÚ 10 ATEX 0092X.