



Product information
Flow - turbine



Characteristics

System

- Turbine RT

Evaluation

- Display, switching, measurement

Nominal widths

- DN 15..50

Range

- 1,8..1133 l/min

Media

- Water, Aqueous emulsions, Aggressive media (Oils)

Pressure resistance

- max. 250 bar

Medium temperature

- -20..+100 °C

Function and benefits

- Uncomplicated measurement of flows
- No magnets in the flow areas, because the hall sensor is pre-tensioned
- Modular system in the evaluation electronics
- Long service life due to high-quality Wolfram carbide bearing
- Intrinsically safe behavior

The sensor is comprised of an turbine vane, which is set in rotation by the flow speed. The rotation is proportional to the flow value per time.

All converters which accept a frequency signal as an input signal (see frequency range of the various areas) can be combined with a electronic evaluation. See also device overview.

Applications

- Industrial metering and monitoring technology
- Test equipment
- Oil circulation control

Note

However, it must be ensured that the flow sensor is always filled with medium and remains filled. Any arbitrary installation position is possible, however, the best-possible bleeding position should be selected (flow from left to right or from bottom to top).

Attention: Air bubbles have a significant, negative impact of the measurement results!

The valve should always be installed after the sensor for emptying processes. Factor in a start-up time (approx. 0.5 sec) and an after-run time (approx. 3 sec).

All specifications provided are based on a run-in and run-out section of 10 x D.

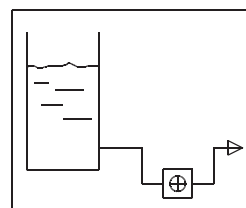

Turbine always under liquid

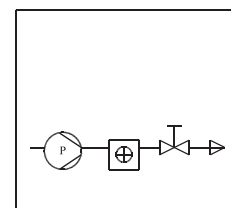

Turbine before valve

Product information Flow - turbine

Programmability of parameters

All type RT. turbines can be combined with the intelligent sensor families OMNI, FLEX and LABO. These sensors have a microcontroller which enables a multitude of parameter changes.

By standard, all three main electronics have the capability of making local changes. In addition, a device configurator (ECI-1) can be used to change all saved parameters of a device at any time, if desired or necessary.

Universal switching outputs

The push-pull transistor outputs enable the simplest installation. You install the output like an NPN switch and it is an NPN switch; you install the output like a PNP switch and it is a PNP switch – without programming or wire breaks.

You are assured a resistance to short circuits and pole reversal and an overload or short circuit is also shown in the display with OMNI electronics.

LABO-RT.- I / U / F / C / S



Pulse programming on pin 2:
Apply the supply voltage level for one second and save the current value as the final value (for analog outputs) or as a switching value (for limit value switches).

OMNI-VHS



Programming with magnet ring:
With the aid of the display and of the movable ring, numerous parameters can be conveniently set on the spot.

FLEX-VHS



Programming with magnet clip:
Hold the magnet to the marking for 1 second and save the present value as the final value (for analog outputs) or as a switching value (for limit value switches).

ECI-1



If required, all parameters can be set at any time on all intelligent sensors, using the ECI-1 device configurator.

Device overview

Device	Range l/min	Pressure resistance in bar	Medium temperature	Supply voltage	Display	Output signal		Page
						Switching	Measuring	
HV	0,6..50	PN 10	-20..+100 °C	-	Analog	-	-	5
RRF-	0,5..30	PN 14	-20..+100 °C	5..24V DC	-	-	Frequency Open Collector OC	6
RT-	1,8..1133	PN 250	-20..+85 °C (150 °C)	10..30V DC	Signal LED	-	Frequency Push-Pull	8
LABO-RT-..S	1,8..1133	PN 250	-20..+85 °C (150 °C)	15..30V DC	Signal LED	1 x Push-Pull	-	10
LABO-RT-..I	1,8..1133	PN 250	-20..+85 °C (150 °C)	10..30V DC	Signal LED	-	4..20 mA	14
LABO-RT-..U	1,8..1133	PN 250	-20..+85 °C (150 °C)	15..30V DC	Signal LED	-	0..10 V	14
LABO-RT-..F	1,8..1133	PN 250	-20..+85 °C (150 °C)	18..30V DC	Signal LED	-	Programmable F / F Transducer 0..2 kHz Push-pull	14
LABO-RT-..C	1,8..1133	PN 250	-20..+85 °C (150 °C)	10..30V DC	Signal LED	-	1 pulse per defined quantity Push-Pull	14
FLEX-RT	1,8..1133	PN 250	-20..+85 °C (150 °C)	18..30V DC	Signal LED	1 x Push-Pull	0/4..20 mA or 0..10 V or Frequen	17
OMNI-RT	1,8..1133	PN 250	-20..+85 °C (150 °C)	18..30V DC	Graphics LCD illuminated transfective and signal LED	2 x Push-Pull	0/4..20 mA or 0..10 V	21
OMNI-Counter-OPTION-C	Preset Counter with external reset facility, anti-complementary switching outputs and actual value display.							25
OMNI-Counter-OPTION-C1	Instantaneous value display with analog output, pulse output and volume totalizer.							28
ECI-1	All LABO, FLEX, and OMNI parameters can be set or modified using the ECI-1 configurator.							31
Options	<ul style="list-style-type: none"> o LABO transmitter – Temperature up to 150 ° o OMNI – Tropical model 							32 32
Accessories	<ul style="list-style-type: none"> o Type ZV / ZE (Filter) o KB.... (Round plug connector 4/5-pin) o OMNI-TA (Panel meter) o OMNI-remote 							33 33 33 33

Errors and technical modifications reserved.

Flow Indicator HV



- Bidirectional
- 360 ° visibility

Characteristics

The flow indicator HV is used for the reliable display of transparent fluids. A signal-red turbine wheel rotates in a glass tube proportional to the flow, and in this way provides an indication of the flow rate present.

The devices provide 360 ° vision, and are built for a long working life, thanks to the design of the turbine's bearings.

Technical data

Nominal width	DN 8..25	
Process connection	female thread G 1/4..G 1	
Display range	0.6..50 l/min	for details see table "Ranges"
Q_{max.}	to 50 l/min	
Pressure resistance	PN 10 bar	
Medium temperature	-20..+100 °C	
Ambient temperature	-20..+70 °C	
Materials medium-contact	body	: PPh
	process connection	: brass
	turbine	: PPh
	Axis	: PPh
	Axis bushes	: 1.4301
	glass	: borosilicate
	seals	: NBR
Medium	water (oils have a tendency to a higher rotor start-up value)	
Weight	see table "Dimensions and weights"	
Installation location	as desired, except for inwards flow from above	

Ranges

G	Start-up quantity for turbine, l/min			Q _{max.} recommended	Types
	H ₂ O	40 mm ² /s	41..150 mm ² /s		
G 1/4	0.6	2.5	3.5	6	HV-008GM
G 3/8	1.2	3.0	4.0	10	HV-010GM
G 1/2				15	HV-015GM
G 3/4	2.1	3.7	5.0	30	HV-020GM
G 1				50	HV-025GM

Special ranges are available.

Dimensions and weights

G	Types	A	B	C	SW	Weight kg
G 1/4	HV-008GM	66	22	44	20	0.11
G 3/8	HV-010GM	92	36	60	28	0.18
G 1/2	HV-015GM					
G 3/4	HV-020GM	114	46	70	46	0.60
G 1	HV-025GM					

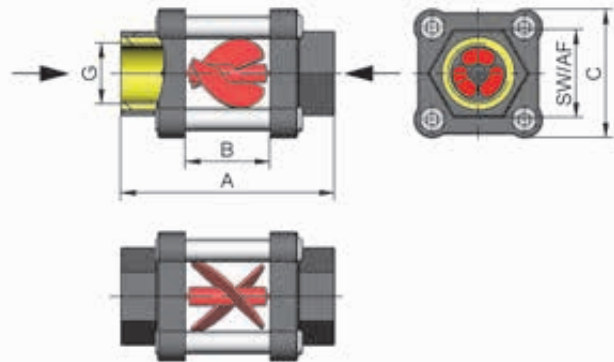

Ordering code

HV - 1. 2. 3.
HV - **G** **M**

1. Nominal width	
008	DN 8 - G 1/4
010	DN 10 - G 3/8
015	DN 15 - G 1/2
020	DN 20 - G 3/4
025	DN 25 - G 1
2. Process connection	
G	female thread
3. Connection material	
M	brass

Flow Transmitter Lineflow RRF



- High accuracy / repeatability at low costs
- Determination of low flow rates
- Independent of location

Characteristics

With the RRF flow meter, an inline turbine is fitted in a plastic housing. A Hall sensor detects, contact-free, the rotation of the turbine, and outputs a frequency signal proportional to the flow.

Technical data

Sensor	turbine fitted with magnets with Hall sensor
Nominal width	DN 10
Process connection	male thread G 3/8 A
Metering range	0.5..30 l/min, for details see table "Ranges and pressure loss"
Measurement accuracy	±3 % of the measured value
Repeatability	±0.5 % of full scale value
Medium temperature	-20..+100 °C
Ambient temperature	0..80 °C
Pressure resistance	PN 14 bar
Pressure loss	see table "Ranges and pressure loss"
Supply voltage	5..24 V DC at 8 mA
Frequency output	NPN open collector at 50 mA max. (1 to 2.2 K Ohm pull-up resistor required)
Electrical connection	cable 1 m or open plug contact 2.8/6.3 x 0.8
Materials	Housing PA 12 Turbine PA 12 Bearing PTFE 15 % graphite
Ingress protection	Cable IP60 Plug contact IP00
Weight	0.04 kg
Conformity	CE

Ranges and pressure loss

Types	Metering range	Pulses/ litre	Frequency at Q _{max}	Pressure loss code (see diagram)
RRF-010AN	l/min H ₂ O		Hz	
005	0.5.. 5	6900	575	A
010	1.0..10	3300	550	A
015	1.0..15	2200	550	A
030	2.0..30	1000	500	B

Pressure loss

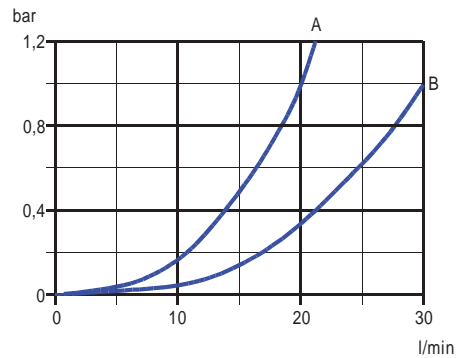

Wiring

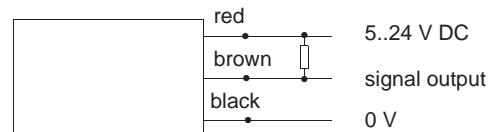

Dimensions

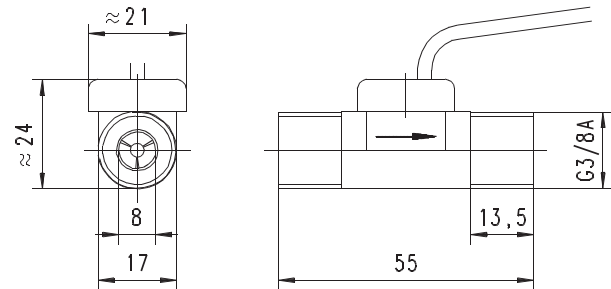

Handling and Operation

Installation

The turbine's direction of flow is marked by an arrow on the housing. Ideally, flow should be from bottom to top. In any case, prevent entrapment of air. Pressure surges when starting up can damage the turbine. The turbine should therefore first be flooded slowly, and only then should the nominal flow be applied. It should preferably be installed ahead of and not after valves in order to prevent the turbine from running empty.

The turbine is sealed into the pipework using Teflon tape or similar. It should be ensured that the thread is not damaged by tightening too strongly. Bending forces on the turbine caused by the pipework must be avoided under all circumstances.

Ordering code

1. 2. 3. 4. 5.
RRF-

○=Option

1. Nominal width	010	DN 10 - G ³ / ₈
2. Process connection	A	male thread
3. Housing material	N	nylon
4. Metering range	005	0.5.. 5 l/min
	010	1.0..10 l/min
	015	1.0..15 l/min
	030	2.0..30 l/min
5. Electrical connection	K	cable connection
	F	<input type="radio"/> open plug contact

Accessories

- OMNI-TA converter / counter for control panel installation

Flow Transmitter RT-...AK



- High precision
- No magnetic components in the flow space
- High pressure resistance

Characteristics

A turbine acts as the primary sensor; its rotational speed is proportional to the flow rate. The rotational speed is detected by means of a biased Hall sensors, i.e. there are no magnets in the flow space.

Technical data

Sensor	biased Hall sensor	
Nominal width	DN 15..50	
Process connection	male thread G 1/2 A...G 2 A	
Metering ranges	1.8..1133 l/min for details, see table "Ranges"	
Measurement accuracy	±1 % of full scale value in the specified metering range, including linearity and repeatability	
Medium temperature	-20..+85 °C optionally -20..+150 °C (for 8 bar min.)	
Ambient temperature	-20..+70 °C	
Storage temperature	-20..+80 °C	
Materials medium-contact	Housing	stainless steel 315
	Turbine	stainless steel 430
	Bearing	tungsten carbide
Material electronics housing	CW614N nickelled	
Max. particle size	0.5 mm	
Pressure loss	0.3 bar at Q _{max} .	
Pressure resistance	PN 250 bar	
Supply voltage	10..30 V DC	
Signal output	transistor output "push-pull" (resistant to short circuits and polarity reversal) I _{out} = 100 mA max.	
Current consumption	20 mA without load	
Max. load current	100 mA	
Electrical connection	for round plug connector M12x1, 4-pole	

Ingress protection	IP 67
Weight	see table "Dimensions"
Conformity	CE

Ranges

Types	Metering range (1..5 mm ² /s)		Pulses / litre ±10 %
	l/min	m ³ /h	
RT-015AK001.	1.8.. 18	0.11.. 1.1	2900
RT-020AK002.	3.7.. 37	0.22.. 2.2	1700
RT-020AK004.	6.7.. 67	0.40.. 4.0	1100
RT-020AK008.	13.3.. 133	0.80.. 8.0	400
RT-025AK016.	26.7.. 267	1.60.. 16.0	190
RT-040AK034.	56.7.. 567	3.40.. 34.0	60
RT-050AK068.	113.3..1133	6.80.. 68.0	24

Wiring

Push-pull output, can be connected to PNP or NPN inputs.

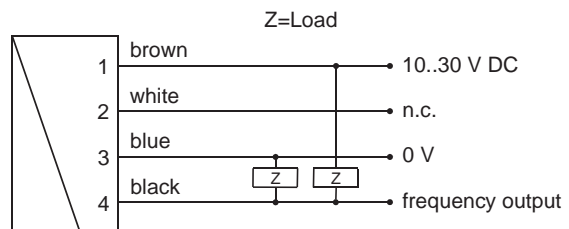

Connection example: PNP NPN

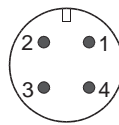

Dimensions

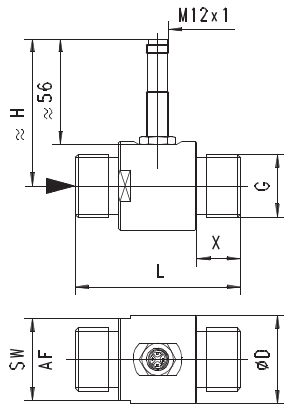

DN	G	ØD	SW / AF	H	L	X	Range m³/h at 1-5 mm² /s	Weight kg
15	1/2	38	35	71	64	19	0.11 – 1.1	0.30
20	3/4	38	35	72	64	19	0.22 – 2.2	0.40
20	3/4	38	35	72	64	19	0.40 – 4.0	0.40
20	3/4	40	38	75	83	22	0.80 – 8.0	0.40
25	1	47	44	78	88	23	1.60 – 16.0	0.60
40	1 1/2	60	52	84	114	28	3.40 – 34.0	1.40
50	2	70	64	89	132	29	6.80 – 68.0	1.90

Handling and Operation

Installation

As with all flow meters, if possible the turbine should be installed ahead of a valve (on the pressure side). Good degassing should be ensured. 10 x D calming sections are recommended before and after the turbine in order to maintain the specified accuracies. The turbine should be filled with fluid at all times. The electronics housing does not project into the flow space.

Ordering code

1. 2. 3. 4. 5. 6.
RT-

○=Option

1. Nominal width									
015	DN 15 - G 1/2 A								
020	DN 20 - G 3/4 A								
025	DN 25 - G 1 A								
040	DN 40 - G 1 1/2 A								
050	DN 50 - G 2 A								
2. Mechanical connection									
A	male thread								
3. Housing material									
K	stainless steel								
4. Metering range									
001	0.11.. 1.1 m³/h								●
002	0.22.. 2.2 m³/h								●
004	0.40.. 4.0 m³/h								●
008	0.80.. 8.0 m³/h								●
016	1.60..16.0 m³/h								●
034	3.40..34.0 m³/h								●
068	6.80..68.0 m³/h								●
5. Signal output									
T	electronics								
6. Option									
H	○ high temperature model								

Options

- Flanged model,
- max. temperature 150 °C
- DN 80-300 PN 16
- model for air / gas
- range from 0.05 m³/h

Accessories

- Cable/round plug connector (KB...) see additional information "Accessories"
- OMNI-TA

Flow Switch LABO-RT-S



- Very short response time
- High precision
- No magnetic components in the flow space
- High pressure resistance

Characteristics

A turbine acts as the primary sensor; its rotational speed is proportional to the flow rate. The rotational speed is detected by means of pre-tensioned Hall sensors, i.e. there are no magnets in the flow space.

The integrated converter / counter make available an electronic switching output (push-pull) with adjustable characteristics (minimum/maximum) and hysteresis, which responds when an adjustable limit is fallen short of or exceeded. The switching value can be set to the currently existing flow using "teaching".

Models with analog or pulse output are also available.

Technical data

Sensor	turbine with biased Hall sensor	
Nominal width	DN 15..50	
Process connection	G 1/2 A...G 2 A (others on request)	
Switching ranges	see table "Ranges"	
Measurement accuracy	±1 % of full scale value in the specified metering range including linearity and repeatability	
Pressure loss	0.3 bar at Q _{max} .	
Pressure resistance	PN 250 bar	
Medium temperature	-20..+85 °C optionally -20..+150 °C (for 8 bar min.)	
Ambient temperature	-20..+70 °C	
Storage temp.	-20..+80 °C	
Materials medium-contact	Housing	stainless steel 315
	Turbine	stainless steel 430
	Bearing	tungsten carbide
Material electronics housing	CW614N plated	
Max. particle size	0.5 mm	

Supply voltage	10..30 V DC
Power consumption	< 1 W (without load)
Switching output	transistor output "push-pull" (resistant to short circuits and polarity reversal) I _{out} = 100 mA max.
Display	yellow LED (On = Normal / Off = Alarm / rapid flashing = Programming)
Electrical connection	for round plug connector M12x1, 4-pole
Ingress protection	IP 67
Weight	see table "Dimensions"
Conformity	CE

Ranges

Types	Switching range (1.5 mm ² /s)	
	l/min	m ³ /h
RT-015AK001.	1.8.. 18	0.11.. 1.1
RT-020AK002.	3.7.. 37	0.22.. 2.2
RT-020AK004.	6.7.. 67	0.40.. 4.0
RT-020AK008.	13.3.. 133	0.80.. 8.0
RT-025AK016.	26.7.. 267	1.60.. 16.0
RT-040AK034.	56.7.. 567	3.40.. 34.0
RT-050AK068.	113.3..1133	6.80.. 68.0

Wiring

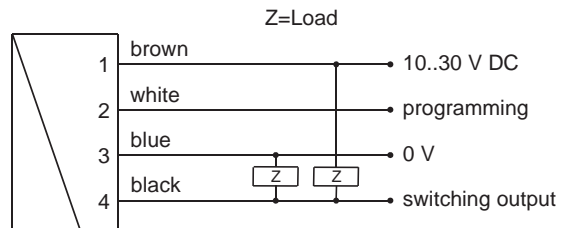

Connection example: PNP NPN

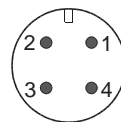

Before the electrical installation, it must be ensured that the supply voltage corresponds to the data sheet.

It is recommended to use shielded wiring.

The push-pull output) can as desired be switched as a PNP or an NPN output.

Dimensions

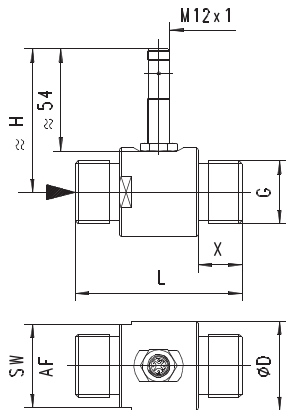

DN	G	ØD	SW / AF	H	L	X	Range m³/h at 1-5 mm² /s	Weight kg
15	1/2	38	35	69	64	19	0.11 – 1.1	0.32
20	3/4	38	35	70	64	19	0.22 – 2.2	0.42
20	3/4	38	35	70	64	19	0.40 – 4.0	0.42
20	3/4	40	38	73	83	22	0.80 – 8.0	0.42
25	1	47	44	76	88	23	1.60 – 16.0	0.63
40	1 1/2	60	52	82	114	28	3.40 – 34.0	1.42
50	2	70	64	87	132	29	6.80 – 68.0	1.92

Handling and operation

Installation

As with all flow meters, if possible the turbine should be installed ahead of a valve (on the pressure side). Good degassing should be ensured. 10 x D calming sections are recommended before and after the turbine in order to maintain the specified accuracies. The turbine should be filled with fluid at all times. The electronics housing does not project into the flow space.

Note

The switching value can be programmed by the user via "teaching". If desired, programmability can be blocked by the manufacturer.

The ECI-1 device configurator with associated software is available as a convenient option for programming all parameters by PC, and for adjustment.

Operation and programming

The switching value is set as follows:

- Apply the flow rate to be set to the device.
- Apply an impulse of at least 0.5 seconds and max. 2 seconds duration to pin 2 (e.g. via a bridge to the supply voltage or a pulse from the PLC), in order to accept the measured value.
- When the teaching is complete, pin 2 should be connected to 0 V, so as to prevent unintended programming.

The device has a yellow LED which flashes during the programming pulse. During operation, the LED serves as a status display for the switching output.

In order to avoid the need to transit to an undesired operating status during the teach-in, the device can be provided ex-works with a teach-offset. The teach-offset point is added to the currently measured value before saving. The offset point can be positive or negative.

Example: The switching value should be set to 80 l/min. However, it is possible only to reach 60 l/min without problems. In this case, the device would be set using a teach-offset of +20 l/min. At a flow rate of 60 l/min in the process, teaching would then store a value of 80 l/min.

The limit switch can be used to monitor minimal or maximal.

With a minimum-switch, falling below the limit value causes a switchover to the alarm state. Return to the normal state occurs when the limit value plus the set hysteresis is once more exceeded.

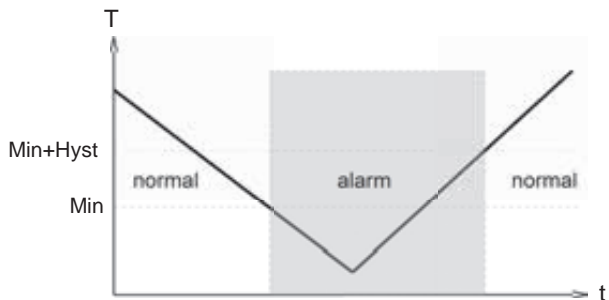

With a maximum-switch, exceeding the limit value causes a switchover to the alarm state. Return to the normal state occurs when the measured value once more falls below the limit value minus the set hysteresis.

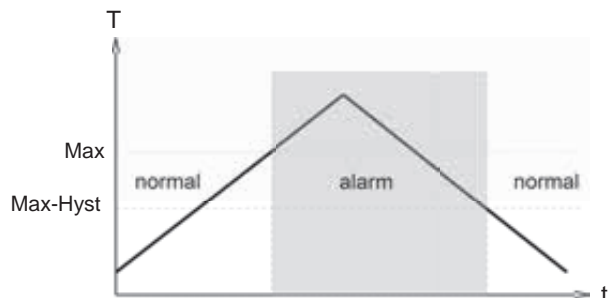

A changeover delay time (t_{DS}) can be applied to switching to the alarm state. Equally, one switch-back delay time (t_{DR}) of several can be applied to switching back to the normal state.

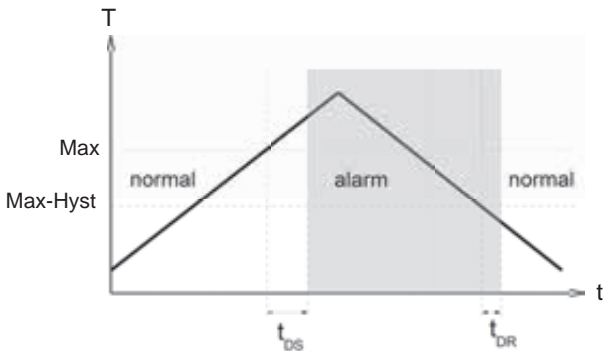

In the normal state the integrated LED is on, in the alarm state it is off, and this corresponds to its status when there is no supply voltage.

In the non-inverted (standard) model, while in the normal state the switching output is at the level of the supply voltage; in the alarm state it is at 0 V, so that a wire break would also display as an alarm state at the signal receiver. Optionally, an inverted switching output can also be provided, i.e. in the normal state the output is at 0 V, and in the alarm state it is at the level of the supply voltage.

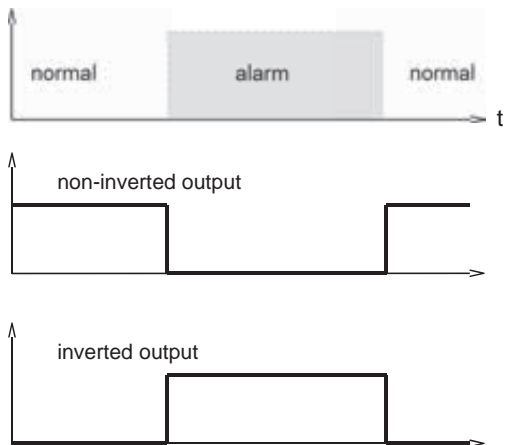

A Power-On-Delay function (ordered as a separate option) makes it possible to maintain the switching output in the normal state for a defined period after application of the supply voltage.

Ordering code

The basic device is ordered e.g. RT-xxx with electronics e.g. LABO-RT-xxx

RT - 1. 2. **A** 3. **K** 4. 5. **E**

LABO - RT- 6. **S** 7. 8. 9. 10. **S** 11.

○ = Option

1. Nominal width	
015	DN 15 - G 1/2 A
020	DN 20 - G 3/4 A
025	DN 25 - G 1 A
040	DN 40 - G 1 1/2 A
050	DN 50 - G 2 A
2. Mechanical connection	
A	male thread
3. Housing material	
K	stainless steel
4. Metering range	
001	0.11.. 1.1 m³/h
002	0.22.. 2.2 m³/h
004	0.40.. 4.0 m³/h
008	0.80.. 8.0 m³/h
016	1.60.. 16.0 m³/h
034	3.40.. 34.0 m³/h
068	6.80.. 68.0 m³/h
5. Connection for	
E	electronics
6. Switching output (Limit switch)	
S	push-pull (compatible with PNP and NPN)
7. Programming	
P	programmable (teaching possible)
N	<input type="radio"/> cannot be programmed (no teaching)
8. Switching function	
L	minimum-switch
H	maximum-switch
9. Switching signal	
O	standard
I	<input type="radio"/> inverted
10. Electrical connection	
S	for round plug connector M12x1, 4-pole
11. Optional	
H	<input type="radio"/> 100 °C version (with 300 mm cable)

Options for LABO

Switching delay period (0.0..99.9 s)
(from Normal to Alarm) . s

Switch-back delay period (0.0..99.9 s)
(from Alarm to Normal) . s

Power-On-Delay period (0..99 s)
(after connecting the supply, time during which the switching output is not actuated) s

Switching output fixed at l/min

Switching hysteresis %
standard = 2 % of the metering range

Teach-offset %
(in percent of the metering range)
Standard = 0 %

Further options available on request.

Options

- Flanged model,
- max. temperature 150 °C
- DN 80-300 PN 16
- model for air / gas
- range from 0.05 m³/h

Accessories

- Cable/round plug connector (KB...) see additional information "Accessories"
- Device configurator ECI-1
- OMNI-TA

Flow Transmitter LABO-RT-I / U / F / C



- High precision
- No magnetic components in the flow space
- High pressure resistance
- 0..10 V, 4..20 mA, frequency/pulse output, completely configurable

Characteristics

A turbine acts as the primary sensor; its rotational speed is proportional to the flow rate. The rotational speed is detected by means of pre-tensioned Hall sensors, i.e. there are no magnets in the flow space.

The LABO-RT electronics make various output signals available:

- Analog signal 0/4..20 mA (LABO-RT-I)
- Analog signal 0/2..10 V (LABO-RT-U)
- Frequency signal (LABO-RT-F) or
- Value signal pulse / x litres (LABO-RT-C)

A model with switching output is also available (see separate datasheet).

If desired, the range end value can be set to the currently existing flow using "teaching".

Technical data

Sensor	turbine with biased Hall sensor
Nominal width	DN 15..50 (others on request)
Process connection	G 1/2 A...G 2 A
Metering ranges	see table "Ranges"
Measurement accuracy	±1 % of full scale value in the specified metering range including linearity and repeatability
Max. particle size	0.5 mm
Pressure loss	0.3 bar at Q _{max} .
Pressure resistance	PN 250 bar
Medium temperature	-20..+85 °C optionally -20..+150 °C (for 8 bar min.)
Ambient temperature	-20..+70 °C
Storage temperature	-20..+80 °C

Materials medium-contact	Housing	stainless steel 315
	Turbine	stainless steel 430
	Bearing	tungsten carbide
Material Electronics housing	CW614N nickelled	
Supply voltage	10..30 V DC voltage output 10 V: 15..30 V DC	
Power consumption	< 1 W (without load)	
Output data:	all outputs are resistant to short circuits and reversal polarity protected	
Current output:	4..20 mA (0..20 mA available on request)	
Voltage output:	0..10 V (2..10 V available on request) output current max. 20 mA	
Frequency output:	transistor output "push-pull" I _{out} = 100 mA max.	
Pulse output:	transistor output "push-pull" I _{out} = 100 mA max. pulse width 50 ms pulse per volume is to be stated	
Display	yellow LCD shows operating voltage (LABO-RT-I / U) or output status (LABO-RT-F / C) (rapid flashing = Programming)	
Electrical connection	for round plug connector M12x1, 4-pole	
Ingress protection	IP 67	
Weight	see table in "Dimensions"	
Conformity	CE	

Signal output curves

Value x = Begin of the specified range

Current output

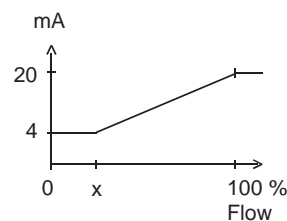

Voltage output

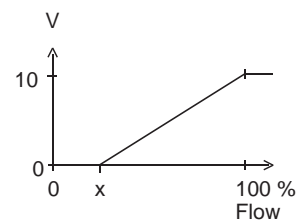

Frequency output

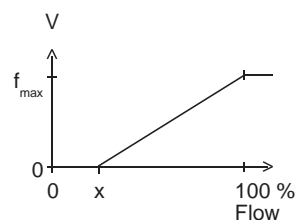

f_{max} selectable in the range of up to 2000 Hz

Other characters on request.

Ranges

Types	Metering range (1..5 mm ² /s)	
	l/min	m ³ /h
RT-015AK001.	1.8.. 18	0.11.. 1.1
RT-020AK002.	3.7.. 37	0.22.. 2.2
RT-020AK004.	6.7.. 67	0.40.. 4.0
RT-020AK008.	13.3.. 133	0.80.. 8.0
RT-025AK016.	26.7.. 267	1.60..16.0
RT-040AK034.	56.7.. 567	3.40..34.0
RT-050AK068.	113.3..1133	6.80..68.0

Wiring

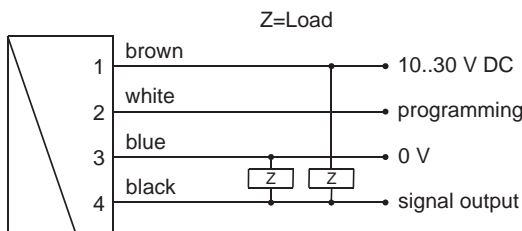

Connection example: PNP NPN

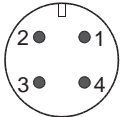

Before the electrical installation, it must be ensured that the supply voltage corresponds to the data sheet.

It is recommended to use shielded wiring.

The push-pull output of the frequency or pulse output version can as desired be switched as a PNP or an NPN output.

Dimensions

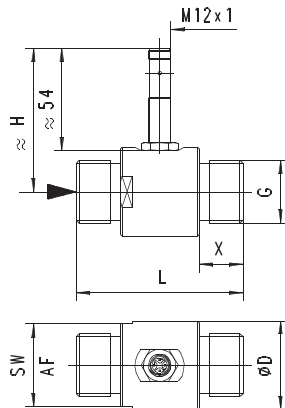

DN	G	ØD	SW / AF	H	L	X	Range m ³ /h at 1-5 mm ² /s	Weight kg
15	1/2	38	35	69	64	19	0.11 – 1.1	0.32
20	3/4	38	35	70	64	19	0.22 – 2.2	0.42
20	3/4	38	35	70	64	19	0.40 – 4.0	0.42
20	3/4	40	38	73	83	22	0.80 – 8.0	0.42
25	1	47	44	76	88	23	1.60 – 16.0	0.63
40	1 1/2	60	52	82	114	28	3.40 – 34.0	1.42
50	2	70	64	87	132	29	6.80 – 68.0	1.92

Handling and operation

Installation

As with all flow meters, if possible the turbine should be installed ahead of a valve (on the pressure side). Good degassing should be ensured. 10 x D calming sections are recommended before and after the turbine in order to maintain the specified accuracies. The turbine should be filled with fluid at all times.

The electronics housing does not project into the flow space.

Note

The fullscale end value can be programmed by the user via "teaching". Requirement for programmability must be stated when ordering, otherwise the device cannot be programmed.

The ECI-1 device configurator with associated software is available as a convenient option for programming all parameters by PC, and for adjustment.

The teaching option is not available for the pulse output version.

Operation and programming

The teaching process can be carried out by the user as follows:

- The flow rate to be set is applied to the device.
- Apply an impulse of at least 0.5 seconds and max. 2 seconds duration to pin 2 (e.g. via a bridge to the supply voltage or a pulse from the PLC), in order to accept the measured value.
- When the teaching is complete, pin 2 should be connected to 0 V, so as to prevent unintended programming.

The devices have a yellow LED which flashes during the programming pulse. During operation, the LED serves as an indicator of operating voltage (for analog output) or of switching status (for frequency or pulse output).

To avoid the need to transit to an undesired operating status for the purpose of teaching, the device can be provided ex-works with a teach-offset. The teach-offset point is added to the currently measured value before saving. The offset point can be positive or negative.

Example: The end of the metering range should be set to 80 %. However, only 60 % can be achieved without problem. In this case, the device would be ordered with a "teach-offset" of +20%.. At a flow rate of 60 % in the process, teaching would then store a value of 80 %.

If necessary, a far greater number of parameters can also be programmed using the ECI-1 device configurator.

Ordering code

The base device RT-XXX is ordered with electronics
e.g. LABO-RT-xxxx

RT - 1. 2. **A** 3. **K** 4. 5. **E**

LABO - RT- 6. 7. 8. **S** 9.

○=Option

1. Nominal width	
015	DN 15 - G 1/2 A
020	DN 20 - G 3/4 A
025	DN 25 - G 1 A
040	DN 40 - G 1 1/2 A
050	DN 50 - G 2 A
2. Mechanical connection	
A	male thread
3. Housing material	
K	stainless steel
4. Metering range	
001	0.11.. 1.1 m³/h
002	0.22.. 2.2 m³/h
004	0.40.. 4.0 m³/h
008	0.80.. 8.0 m³/h
016	1.60..16.0 m³/h
034	3.40..34.0 m³/h
068	6.80..68.0 m³/h
5. Connection for	
E	electronics
6. Signal output	
I	current output 4..20 mA
U	voltage output 0..10 V
F	frequency output (see "Ordering information")
C	pulse output (see "Ordering information")
7. Programming	
N	cannot be programmed (no teaching)
P	<input type="radio"/> programmable (teaching possible)
8. Electrical connection	
S	for round plug connector M12x1, 4-pole
9. Optional	
H	<input type="radio"/> 100 °C version (with 300 mm cable)

Required ordering information

For LABO-RT-F:

Output frequency at full scale

Hz

Maximum value: 2.000 Hz

For LABO-RT-C:

For the pulse output version, the volume (with numerical value and unit) which will correspond to one pulse must be stated.

Volume per pulse (numerical value)

Volume per pulse (unit)

Options for LABO

Special range for analog output:

<= metering range (standard=metering range)

l/min

Special range for frequency output:

<= metering range (standard=metering range)

l/min

Power-On delay period (0..99 s)

(time after applying power during which the outputs are not actuated or set to defined values)

s

Further options available on request.

Options

- Flanged model,
- max. temperature 150 °C
- DN 80-300 PN 16
- model for air / gas
- range from 0.05 m³/h

Accessories

- Cable/round plug connector (KB...) see additional information "Accessories"
- converter / counter OMNI-TA
- Device configurator ECI-1

Flow Transmitter / Switch FLEX-RT



- Versatile turbine flow sensor
- Switching output and analog output (4..20 mA / 0..10 V)
- Top quality materials
- Designed for industrial use
- Ingress protection IP 67
- Infinitely adjustably rotatable cable outlet for clean alignment
- Small, compact construction
- Very simple installation

Characteristics

A turbine acts as the primary sensor; its rotational speed is proportional to the flow rate. The rotational speed is detected by means of a biased Hall sensors, i.e. there are no magnets in the flow space.

The FLEX transducer located on the sensor has an analog output (4..20 mA or 0..10 V) and a switching output, which can be configured as a limit switch for monitoring minimal or maximal, or as a frequency output.

The switching output is designed as a push-pull driver, and can therefore be used both as a PNP or an NPN output. The state of the switching output is signalled with a yellow LED in the switching outlet; the LED has all-round visibility.

The sensor is configured in the factory, or alternatively this can be done with the aid of the optionally available ECI-1 device configurator (USB interface for PC). A selectable parameter can be modified on the device, with the aid of the magnet clip provided. In this case, the current measured value is saved as the parameter value. Examples of these parameters are the switching value or the metering range end value.

The stainless steel electronics housing is rotatable, so it is possible to orient the cable outlet after installation.

Technical data

Sensor	turbine with biased Hall sensor	
Nominal width	DN 15..50 (others on request)	
Process connection	G 1/2 A...G 2 A	
Metering ranges	see table "Ranges"	
Measurement accuracy	±1 % of full scale value in the specified metering range including linearity and repeatability	
Medium temperature	-20..+85 °C optionally -20..+150 °C (for 8 bar min.)	
Ambient temperature	-20..+70 °C	
Storage temperature	-20..+80 °C	
Materials medium-contact	Housing	stainless steel 316
	Turbine	stainless steel 430
	Bearing	tungsten carbide
Material electronics housing	stainless steel 1.4305 adapter CW614N plated	
Max. particle size	0.5 mm	
Pressure loss (average)	0.3 bar at Q _{max}	
Pressure	PN 250 bar	
Supply voltage	18..30 V DC	
Power consumption	<1 W	
Analog output	4..20 mA / load 500 Ohm max. or 0..10 V / load min. 1 kOhm	
Switching output	transistor output "push-pull" (resistant to short circuits and polarity reversal) I _{out} = 100 mA max.	
Switching hysteresis	adjustable (please state when ordering) Standard setting: 2 % F.S., for Min-switch, position of the hysteresis above the limit value, and for Max-switch, below the limit value	
Display	yellow LED (On = Normal / Off = Alarm)	
Electrical connection	for round plug connector M12x1, 4-pole	
Ingress protection	IP 67	
Weight	see table in "Dimensions"	
Conformity	CE	

Signal output curves

Value x = Begin of the specified range

Current output

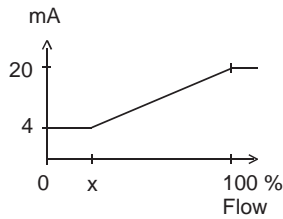

Voltage output

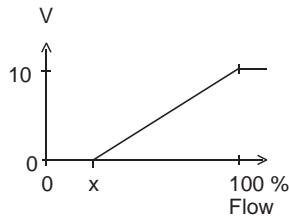

Frequency output

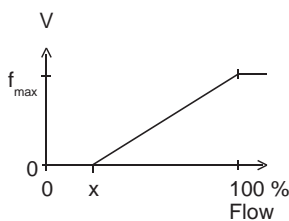

f_{max} selectable in the range of up to 2000 Hz

Other characters on request.

Ranges

Types	Metering range (1..5 mm ² /s)	
	l/min	m ³ /h
RT-015AK001.	1.8.. 18	0.11.. 1.1
RT-020AK002.	3.7.. 37	0.22.. 2.2
RT-020AK004.	6.7.. 67	0.40.. 4.0
RT-020AK008.	13.3.. 133	0.80.. 8.0
RT-025AK016.	26.7.. 267	1.60..16.0
RT-040AK034.	56.7.. 567	3.40..34.0
RT-050AK068.	113.3..1133	6.80..68.0

Wiring

Before the electrical installation, it must be ensured that the supply voltage corresponds with the data sheet.

It is recommended to use shielded wiring,

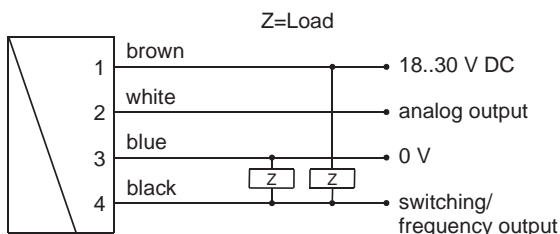

Connection example: PNP NPN

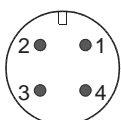

Dimensions

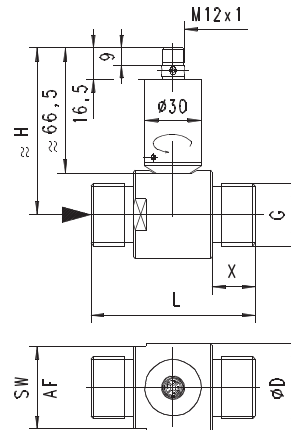

DN	G	ØD	SW / AF	H	L	X	Range m ³ /h at 1-5 mm ² /s	Weight kg
15	1/2	38	35	81.5	64	19	0.11 – 1.1	0.44
20	3/4	38	35	82.5	64	19	0.22 – 2.2	0.54
20	3/4	38	35	82.5	64	19	0.40 – 4.0	0.54
20	3/4	40	38	85.5	83	22	0.80 – 8.0	0.54
25	1	47	44	88.5	88	23	1.60 – 16.0	0.74
40	1 1/2	60	52	94.5	114	28	3.40 – 34.0	1.54
50	2	70	64	99.5	132	29	6.80 – 68.0	2.04

Handling and operation

Installation

As with all flow meters, if possible the turbine should be installed ahead of a valve (on the pressure side). Good degassing should be ensured. 10 x D calming sections are recommended before and after the turbine in order to maintain the specified accuracies. The turbine should be filled with fluid at all times. The electronics housing does not project into the flow space.

Programming

The electronics contain a magnetic contact, with the aid of which different parameters can be programmed. Programming takes place when a magnet clip is applied for a period between 0.5 and 2 seconds to the marking located on the label. If the contact time is longer or shorter than this, no programming takes place (protection against external magnetic fields).



After the programming ("teaching"), the clip can either be left on the device, or removed to protect data.

The device has a yellow LED which flashes during the programming pulse. During operation, the LED serves as a status display for the switching output.

In order to avoid the need to transit to an undesired operating status during "teaching", the device can be provided ex-works with a "teach-offset". The "teach-offset" value is added to the currently measured value before saving (or is subtracted if a negative value is entered).

Example: The switching value is to be set to 70 % of the metering range, because at this flow rate a critical process status is to be notified. However, only 50% can be achieved without danger. In this case, the device would be ordered with a "teach-offset" of +20 %. At 50 % in the process, a switching value of 70 % would then be stored during "teaching".

Normally, programming is used to set the limit switch. However, if desired, other parameters such as the end value of the analog or frequency output may also be set.

The limit switch can be used to monitor minimal or maximal.

With a minimum-switch, falling below the limit value causes a switchover to the alarm state. Return to the normal state occurs when the limit value plus the set hysteresis is again exceeded.

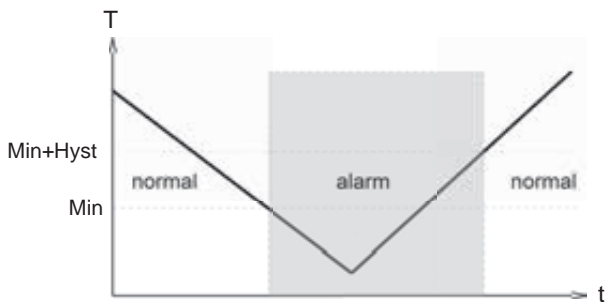

With a maximum-switch, exceeding the limit value causes a switchover to the alarm state. Return to the normal state occurs when the measured value once more falls below the limit value minus the set hysteresis.

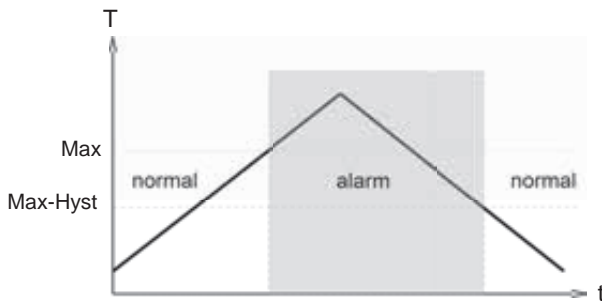

A switchover delay time (t_{DS}) can be applied to the switchover to the alarm state. Equally, one switch-back delay time (t_{DR}) of several can be applied to switching back to the normal state.

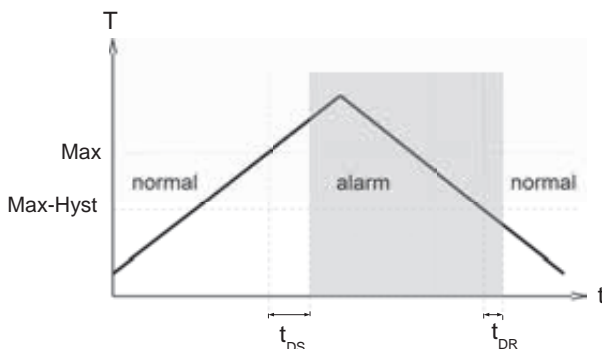

In the normal state the integrated LED is on, in the alarm state it is off, and this corresponds to its status when there is no supply vol-

ge.

In the non-inverted (standard) model, while in the normal state the switching output is at the level of the supply voltage; in the alarm state it is at 0 V, so that a wire break would also display as an alarm state at the signal receiver. Optionally, an inverted switching output can also be provided, i.e. in the normal state the output is at 0 V, and in the alarm state it is at the level of the supply voltage.

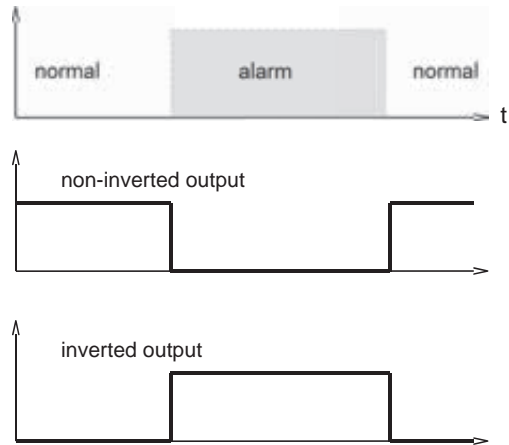

A Power-On delay function (ordered as a separate option) makes it possible to maintain the switching output in the normal state for a defined period after application of the supply voltage.

Ordering code

The base device RT-XXX is ordered with FLEX-RT-XXX electronics.

RT- 1. 2. **A** 3. **K** 4. 5. **E**

FLEX-RT- 6. 7. 8. 9. 10.

○=Option

1. Nominal width									
015	DN 15 - G 1/2 A								
020	DN 20 - G 3/4 A								
025	DN 25 - G 1 A								
040	DN 40 - G 1 1/2 A								
050	DN 50 - G 2 A								
2. Mechanical connection									
A	male thread								
3. Housing material									
K	stainless steel								
4. Metering range									
001	0.11.. 1.1 m³/h								●
002	0.22.. 2.2 m³/h								●
004	0.40.. 4.0 m³/h								●
008	0.80.. 8.0 m³/h								●
016	1.60..16.0 m³/h								●
034	3.40..34.0 m³/h								●
068	6.80..68.0 m³/h								●
5. Connection for									
E	electronics								
6. For nominal width									
015	DN 15 - G 1/2 A								●
020	DN 20 - G 3/4 A								●
025	DN 25 - G 1 A								●
040	DN 40 - G 1 1/2 A								●
050	DN 50 - G 2 A								●
7. Analog output									
I	current output 4..20 mA								
U	voltage output 0..10 V								
8. Switching function									
L	minimum-switch								
H	maximum-switch								
9. Switching signal									
O	standard								
I	<input type="radio"/> inverted								
10. Option									
H	<input type="radio"/> 150 °C Version (with spacer)								

Options for FLEX

Special range for analog output: /min
(not greater than the sensor's working range)

Special range for frequency output: /min
(not greater than the sensor's working range)

End frequency (max. 2000 Hz) Hz

Switching delay (from Normal to Alarm) . s

Switchback delay (from Alarm to Normal) . s

Power-On delay (0..99 s) s
(time after power on, during which the outputs are not actuated)

Switching output fixed /min

Special hysteresis (standard = 2 % EW) %

Gooseneck
(recommended at operating temperatures above 70 °C)

If the field is not completed, the standard setting is selected automatically.

Options

- Flanged model,
- max. temperature 150 °C
- DN 80-300 PN 16
- model for air / gas
- range from 0.05 m³/h

Accessories

- Cable/round plug connector (KB...) see additional information "Accessories"
- Device configurator ECI-1

Flow Transmitter / Switch OMNI-RT



- Universal turbine flow sensor
- Analog output, two switching outputs
- Clear, easily legible, illuminated LCD display
- Modifiable units in the display
- Designed for industrial use
- Small, compact construction
- Simple installation

Characteristics

A turbine acts as the primary sensor; its rotational speed is proportional to the flow rate. The rotational speed is detected by means of pre-tensioned Hall sensors, i.e. there are no magnets in the flow space.

The OMNI transducer located on the sensor has a backlit graphics LCD display which is very easy to read, both in the dark and in bright sunlight. The graphics display allows the presentation of measured values and parameters in a clearly understandable form. The measured values are displayed to 4 places, together with their physical unit, which may also be modified by the user. The electronics have an analog output (4..20 mA or 0..10 V) and two switching outputs, which can be used as limit switches for monitoring minimal or maximal, or as two-point controllers.

The switching outputs are designed as push-pull drivers, and can therefore be used both as PNP and NPN outputs. Exceeding limit values is signalled by a red LED which is visible over a long distance, and by a cleartext in the display. The stainless steel case has a hardened non-scratch mineral glass pane. It is operated by a programming ring fitted with a magnet, so there is no need to open the operating controls housing, and its leakproofness is permanently ensured.

By turning the ring to right or left, it is simple to modify the parameters (e.g. switching point, hysteresis...). To protect from unintended programming, it can be removed, turned through 180° and replaced, or completely removed, thus acting as a key.



OPTION C:

Preset Counter with external reset option, complementary switching outputs and actual value display.

OPTION C1:

Instantaneous value display with analogue output, pulse-volume output and totalizer

Technical data

Sensor	turbine with pre-tensioned Hall sensor	
Nominal width	DN 15..50	
Process connection	G 1/2 A...G 2 A	
Metering ranges	see table "Ranges"	
Measurement accuracy	±1 % of full scale value in the specified metering range including linearity and repeatability	
Medium temperature	-20..+85 °C optionally -20..+150 °C (for 8 bar min.)	
Ambient temperature	-20..+70 °C	
Storage temperature	-20..+80 °C	
Max. particle size	0.5 mm	
Pressure loss	maximum 0.3 bar at Q _{max} .	
Pressure	PN 250 bar	
Materials medium-contact	Housing	stainless steel 316
	Turbine	stainless steel 430
	Bearing	tungsten carbide
Materials Electronic housing	Housing	stainless steel 1.4305
	Glass	mineral glass hardened
	Magnet	samarium-Cobalt
	Ring	POM
Supply voltage	18..30 V DC	
Power consumption	< 1 W	
Analog output	4..20 mA / max. load 500 Ω or 0..10 V / min. load 1 kΩ	
Switching outputs	transistor output "push-pull" (resistant to short circuits and polarity reversal) I _{out} = 100 mA max.	
Hysteresis	adjustable, position of the hysteresis depends on minimum or maximum	
Display	backlit graphical LCD-Display (transreflective), extended temperature range -20..+70 °C, 32 x 16 pixels, background illumination, displays value and unit, flashing LED signal lamp with simultaneous message on the display.	
Electrical connection	for round plug connector M12x1, 5-pole	
Ingress protection	IP 67 / (IP 68 when oil-filled)	
Weight	see table "Dimensions"	
Conformity	CE	

Signal output curves

Value x = Begin of the specified range
 = not specified range

Current output

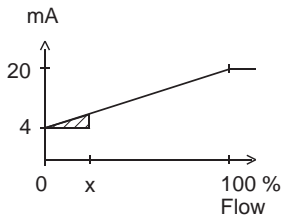

Voltage output

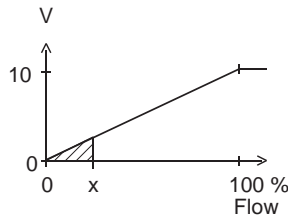

Other characters on request.

Ranges

Types	Metering range (1..5 mm ² /s)	
	l/min	m ³ /h
OMNI-RT-015AK001.	1.8.. 18	0.11.. 1.1
OMNI-RT-020AK002.	3.7.. 37	0.22.. 2.2
OMNI-RT-020AK004.	6.7.. 67	0.40.. 4.0
OMNI-RT-020AK008.	13.3.. 133	0.80.. 8.0
OMNI-RT-025AK016.	26.7.. 267	1.60..16.0
OMNI-RT-040AK034.	56.7.. 567	3.40..34.0
OMNI-RT-050AK068.	113.3..1133	6.80..68.0

Wiring

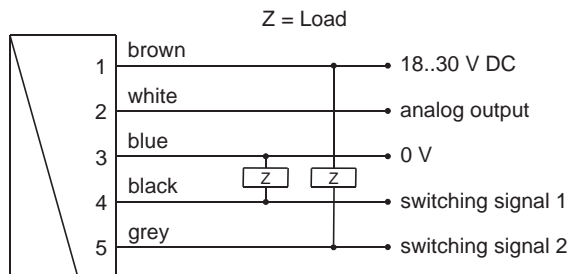

Connection example: PNP NPN

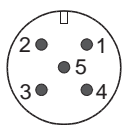

connector M12x1

See separate wiring at C and C1 option in the separate descriptions.

Before the electrical installation, it must be ensured that the supply voltage corresponds to the data sheet.
 The use of shielded cabling is recommended.

Dimensions

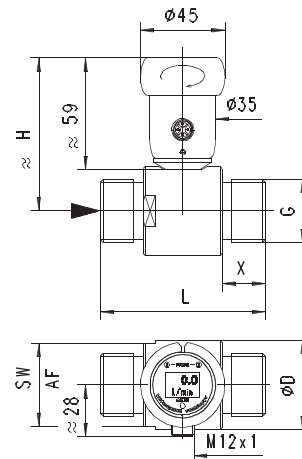

G	DN	ØD	SW / AF	H	L	X	Range m ³ /h at 1-5 mm ² /s	Weight
G 1/2	15	38	35	74	64	19	0.11 – 1.1	0.50
G 3/4	20	38	35	75	64	19	0.22 – 2.2	0.60
G 3/4	20	38	35	75	64	19	0.40 – 4.0	0.60
G 3/4	20	40	38	78	83	22	0.80 – 8.0	0.60
G 1	25	47	44	81	88	23	1.60 – 16.0	0.80
G 1 1/2	40	60	52	87	114	28	3.40 – 34.0	1.60
G 2	50	70	64	92	132	29	6.80 – 68.0	2.10

Gooseneck option



A gooseneck (optional) between the electronics head and the primary sensor provides freedom in the orientation of the sensor. This option simultaneously provides thermal decoupling between the two units.

Handling and operation

Installation

As with all flow meters, if possible the turbine should be installed ahead of a valve (on the pressure side). Good degassing should be ensured. 10 X D calming sections are recommended before and after the turbine in order to maintain the specified accuracies. The turbine should be filled with fluid at all times.

It should be ensured that the flow meter and the OMNI electronics are matched to each other.

The electronics housing is permanently connected to the primary sensor, and cannot be removed by the user. After installation, the electronic head can be turned to the best position for reading.

Programming

The annular gap of the programming ring can be turned to positions 1 and 2. The following actions are possible:



Set to 1 = continue (STEP)
Set to 2 = modify (PROG)

Neutral position between
1 and 2

The ring can be removed to act as a key, or turned through 180° and replaced to create a programming protector. Operation is by dialog with the display messages, which makes its use very simple.

Starting from the normal display (present value and unit), if 1 (STEP) is repeatedly selected, then the display shows the following information in this order:

Display of the parameters, using position 1

- Switching value S1 (switching point 1 in the selected unit)
 - Switching characteristic of S1
MIN = Monitoring of minimum value
MAX = Monitoring of maximum value
 - Hysteresis 1 (hysteresis value of S1 in the set unit)
 - Switching value S2
 - Switching characteristic of S2
 - Hysteresis 2
 - Code
- After entering the **code 111**, further parameters can be defined:
- Filter (settling time of the display and output)
 - Physical unit (Units)
 - Output: 0..20 mA or 4..20 mA
 - 0/4 mA (measured value corresponding to 0/4 mA)
 - 20 mA (measured value corresponding to 20 mA)

For models with a voltage output, replace 20 mA accordingly with 10 V.

Edit, using position 2

If the currently visible parameter is to be modified:

- Turn the annular gap to position 2, so that a flashing cursor appears which displays the position which can be modified.
- By repeatedly turning to position 2, values are increased; by turning to position 1, the cursor moves to the next digit
- Leave the parameter by turning to position 1 (until the cursor leaves the row); this accepts the modification.
- If there is no action within 30 seconds, the device returns to the normal display range without accepting the modification.

The limit switches S1 and S2 can be used to monitor minimal or maximal.

With a minimum-switch, falling below the limit value causes a switchover to the alarm state. Return to the normal state occurs when the limit value plus the set hysteresis is once more exceeded.

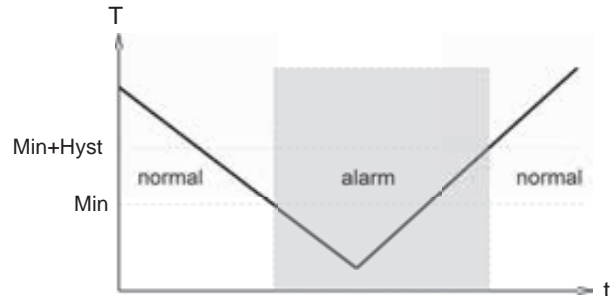

With a maximum-switch, exceeding the limit value causes a switchover to the alarm state. Return to the normal state occurs when the measured value once more falls below the limit value minus the set hysteresis.

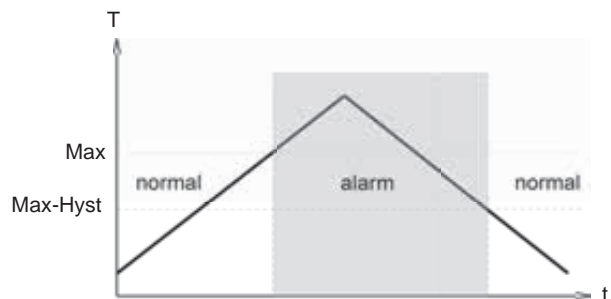

The change to the alarm state is indicated by the integrated red LED and a cleartext in the display.

While in the normal state the switching outputs are at the level of the supply voltage; in the alarm state they are at 0 V, so that a wire break would also display as an alarm state at the signal receiver.

Overload display

Overload of a switching output is detected and indicated on the display ("Check S 1 / S 2"), and the switching output is switched off.

Simulation mode

To simplify commissioning, the sensor provides a simulation mode for the analog output. It is possible to create a programmable value in the range 0..26.0 mA at the output (without modifying the process variable). This allows the wiring run between the sensor and the downstream electronics to be tested during commissioning. This mode is accessed by means of **Code 311**.

Factory settings

After modifying the configuration parameters, it is possible to reset them to the factory settings at any time using **Code 989**.

Ordering code

The basic device is ordered e.g. RT-xxx with electronics e.g. OMNI-RT-xxxx

RT- 1. 2. **A** 3. **K** 4. 5. **E** 6.

OMNI-RT- 7. 8. 9. **S** 10. 11.

○=Option

1. Nominal width									
015	DN 15 - G 1/2 A								
020	DN 20 - G 3/4 A								
025	DN 25 - G 1 A								
040	DN 40 - G 1 1/2 A								
050	DN 50 - G 2 A								
2. Mechanical connection									
A	male thread								
3. Housing material									
K	stainless steel								
4. Metering range									
001	0.11.. 1.1 m³/h								●
002	0.22.. 2.2 m³/h								●
004	0.40.. 4.0 m³/h								●
008	0.80.. 8.0 m³/h								●
016	1.60..16.0 m³/h								●
034	3.40..34.0 m³/h								●
068	6.80..68.0 m³/h								●
5. Connection for									
E	electronics								
6. Option									
H	high temperature model								
7. For nominal width									
015	DN 15 - G 1/2 A								●
020	DN 20 - G 3/4 A								●
025	DN 25 - G 1 A								●
040	DN 40 - G 1 1/2 A								●
050	DN 50 - G 2 A								●
8. Analog output									
I	current output 0/4..20 mA								●
U	voltage output 0/2..10 V								●
K	without								●
9. Electrical connection									
S	for round plug connector M12x1, 5-pole								
10. High temperature									
H	150 °C version								
	tropical model								
O	oil-filled version for heavy duty or external use								
11. Option 2									
C	Counter C								
C1	Counter C1								

Options

Counter C (hardware and software option):
Preset Counter with external reset option, complementary switching outputs and actual value display (modified wiring diagram!)

Counter C1 (software option):
Instantaneous value display with analogue output, pulse-volume output and totalizer

Accessories

- Cable/round plug connector (KB...) see additional information "Accessories"
- Device configurator ECI-1

OMNI-C Counter



Counter for flow transmitters:

- Piston
- Dynamic diaphragm
- Rotor
- Turbine
- Gear
- Screw
- Calorimetry
- MID
- Vortex

- Simple totalisation
- Simple filling counter with programmable end signal
- Control switchover at present value
- Automatic, dynamic change of display unit and decimal places in the graphics display
- Antivalent outputs
- Simple guided menu via graphics display

Characteristics

The totaliser of the OMNI flow rate system enables a totalisation or measurement of consumption for all HONSBERG device families (for fluids and gases) with which the OMNI system is compatible; this is independent of the input signal, pulse or analogue input, and of the measurement process.

Simple filling control is also possible. Here, the counter can be set to count upwards or downwards.

When the preset point is reached, a switching signal is emitted which is available in antivalent form to two outputs. Resetting can be carried out by means of a signal input or also by a programming ring.

The state of the counter is indicated in an LCD display with only four digits. Here, the number of decimal places and the unit displayed is continuously matched to the current state of the counter. In this case, the smallest value which can be displayed is 0.001 ml (= 1 µl), and the largest is 9999 m³. The counter therefore has 13 places, of which the four most significant are displayed at any one time. The display resolution at all times is therefore at least 1 per thousand of the displayed value, or better, and this generally exceeds the accuracy of the connected flow transmitter. The non-displayed digits of the counter are in that case irrelevant to the accuracy of the measurement.

The automatic dynamic changeover of units in the display in relation to the state of the counter makes the value easy to read in spite of a display with only four digits. In addition, user configuration of the counter is unnecessary.

In addition to the totalised value, the present flow rate can be displayed.

Technical data

Counter range	0.000 ml to 9999 m³ with automatic setting of the decimal places and of the applicable unit.
----------------------	---

Switching outputs (Pin 4 + 5)	signal	2 x pushpull output, max. 100 mA, resistant to short circuits and polarity reversal, antivalent states, configurable on the device as a wiper or edge signal
Counter signal (Pin 2)	reset	Input 18..30 V resistant to short circuits and reversed polarity PIN 2, wiper signal, positive or negative edge can be selected locally

Wiring

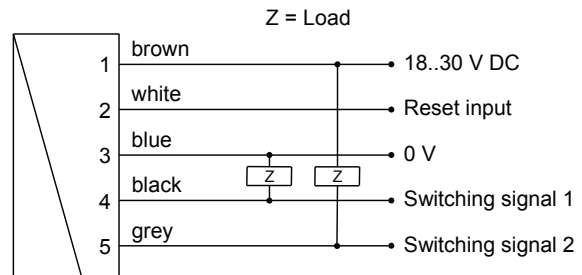

Connection example: PNP NPN

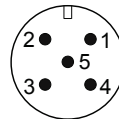

Before the connecting the supply voltage, it must be ensured that this corresponds with the data sheet! The use of shielded cabling is recommended

Sensor connection to OMNI-C-TA, see dimensions.

Handling and operation

Installation

For assembly, please observe the handling instructions for the different device versions.

After assembly, it is possible to move the sensor head to the most optimal reading position opposite the sensor part using its rotating function.

Programming

On the display, the counter indicates the state of the totaliser as a value and unit. The units ml, L, m³ are set automatically.

For operation as a totaliser, no configuration by the user is necessary.

To use the other functions, configuration may be required. This is carried out using the programming ring located on the device.



The annular gap of the programming ring can be turned to positions 1 and 2. The following actions are possible:



Set to 1 = continue (STEP)
Set to 2 = modify (PROG)

Neutral position between 1 and 2

The ring can be removed to act as a key, or turned through 180° and replaced to create a programming protector.

Operation is by dialogue with the display messages, which makes its use very simple.

The control display of the present flow rate depends on the metering range of the selected flow transmitter, and has already been set appropriately in the factory (ml/min, l/min, l/h, m³/h). It is activated by turning the ring to position 1. After 10 seconds, the display automatically returns to the totaliser mode.

For operation as a preset counter, the following must be set:

1. The preset point
2. The type of output signal ("Preset has been reached"):
 - Signal edge / wiper pulse
 - width of the wiper pulse, if required
3. The unit of the preset point: (ml, litre, m³).

Starting from the normal display (total and unit), if 1 (Step) is selected repeatedly, then the counter shows the following information:

- Normal display is total and unit (e.g. litre)
- Display of present value (e.g. l/min)
- Preset point incl. type of switching output.
- Code

The code gives access to various input levels into which parameters can be entered (so that this does not occur inadvertently, the code must be entered!).

Code 111:

- Gate time (available only for sensors which transmit frequency)
- Filter time
- Direction of count (pos / neg)
- Unit for switching value reset point
- Decimal place for switching value / reset point
- Switching type for switching value (edge / wiper signal)
- Pulse duration (for wiper signal)
- Reset method (manual / via signal)

Code 100:

- Manual reset for totaliser

The detailed flow chart for operation is available in the "Operating instructions for OMNI-C".

Combination examples

Vortex CF..	
Calorimetric F.. (separate data sheet)	
Calorimetric FG.. (separate data sheet)	
Calorimetric FIN..	
Magnetic inductive FIS.. (separate data sheet)	
Piston HD.. HR.. MR..	
Magnetic inductive MID1..	
Panel mounting OMNI-TA (separate data sheet)	
Rotor RR..	
Turbine RT..	
Screw VHS..	

Gear VHZ..	
Dynamic diaphragm XF..	

Momentary value indicator, transmitter and meter OMNI-C1 electronics



Counter for flow transmitters:

- Piston
- Dynamic diaphragm
- Rotor
- Turbine
- Gear
- Screw
- MID
- Vortex

- Momentary value indicator and totalisation
- Pulse output with adjustable pulse per volume
- Antivalent outputs
- Analogue output of the momentary value
- Simple guided menu via graphics display

Characteristics

The local OMNI-C1 electronics offers a momentary value indicator and a totalisation of the flow rate quantity.

The momentary value is output at the analogue output as a 4..20 mA signal (or optionally as a 0..10 V signal). In addition, the electronics has a pulse output, which outputs a pulse after a preset quantity with a duration of 36 ms. The pulse is available at two switching outputs in antivalent form.

The primary displayed value is the flow rate. Using the programming ring, you can temporarily switch to the totalisation.

The state of the totalisation is indicated in an LCD display with only four digits. Here, the number of decimal places and the unit displayed is continuously matched to the current state of the counter. In this case, the smallest value which can be displayed is 0.001 ml (= 1 µl), and the largest is 9999 m³. The counter therefore has 13 places, of which the four most significant are displayed at any one time. The display resolution at all times is therefore at least 1 per thousand of the displayed value, or better, and this generally exceeds the accuracy of the connected flow transmitter. The non-displayed digits of the counter are in that case irrelevant to the accuracy of the measurement.

The automatic dynamic changeover of units in the display in relation to the state of the counter makes the value easy to read in spite of a display with only four digits. In addition, user configuration of the counter is unnecessary.

Counter C:

Instead of the counter option C1 the counter option C is available (see corresponding datasheet). It offers a totalizer with adjustable preset value and external reset. This allows to realize a filling control application for example. Additionally the actual flow rate value can be displayed, however without an analog output.

Technical data

Counter range	0.000 ml to 9999 m³ with automatic setting of the decimal places and of the applicable unit
Pulse outputs (Pin 4 + 5)	2 x pushpull output, max. 100 mA, resistant to short circuits and polarity reversal, antivalent statuses, pulse width 36 ms

Wiring

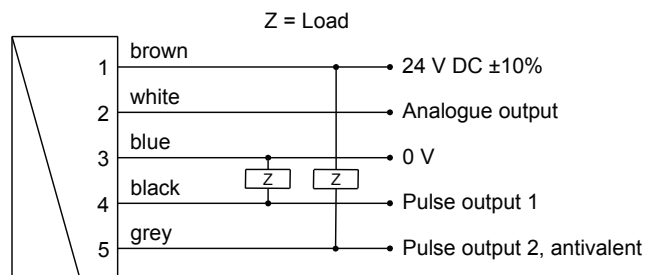

Connection example: PNP NPN

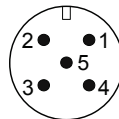

Plug connector M12x1

Before the electrical installation, it must be ensured that the supply voltage corresponds to the data sheet. The use of shielded cabling is recommended.

Handling and operation

Installation

For assembly, please observe the handling instructions for the different device versions.

After assembly, it is possible to move the sensor head to the most optimal reading position opposite the sensor part using its rotating function.

Programming

The resetting of the meter to zero takes place through the programming.

The stainless steel case has a hardened non-scratch mineral glass pane. It is operated by a programming ring fitted with a magnet, so there is no need to open the operating controls housing, and its leakproofness is permanently ensured.

By turning the ring to right or left, it is simple to modify the parameters (e.g. switching point, hysteresis...). To protect from unintended programming, it can be removed, turned through 180 ° and replaced, or completely removed, thus acting as a key.



On the display, the meter indicates the current flow rate as a value and unit. For this purpose, no adjustments by the user are necessary.

To use the other functions, configuration may be required. This is carried out using the programming ring located on the device.

The annular gap of the programming ring can be turned to positions 1 and 2. The following actions are possible:



Set to 1 = continue (STEP)
Set to 2 = modify (PROG)

Neutral position between 1 and 2

The ring can be removed to act as a key, or turned through 180 ° and replaced to create a programming protector. Operation is by dialogue with the display messages, which makes its use very simple.

Rotating the ring once to Pos. 1 displays the totaliser status. In the process, the unit is automatically set to the quantity already counted. After 10 seconds, the display automatically returns to the momentary value mode. If the ring is turned to position 1 again while the totaliser status is shown, the code input is reached. The code gives access to various input levels into which parameters can be changed (so that this does not occur inadvertently, the code must be entered!).

Code 100:

Reset for totaliser

Code 111:

Filter

Enables the input of a filter time in multiple levels

The filter time describes the time after which a volatile change in flow occurs until the display value has adopted the new value

PisUnit

Enables the input of the unit of the pulse volume (pulse per volume), e.g. cm³, Litre, m³

PisVal

Enables the input of the meter value of the pulse flow (0..9999)

Output

Enables switching of the analogue output between 0..20 mA and 4..20 mA (optionally (0..10 V and 2..10 V)

4 mA

Defines the momentary value at which 4 mA should be output

20 mA

Defines the momentary value at which 20 mA should be output

Combination examples

Vortex CF..	
Calorimetric F.. (separate data sheet)	
Calorimetric FG.. (separate data sheet)	
Calorimetric FIN..	
Magnetic inductive FIS.. (separate data sheet)	
Piston HD.. HR.. MR..	
Magnetic inductive MID1..	
Panel mounting OMNI-TA (separate data sheet)	
Rotor RR..	
Turbine RT..	
Screw VHS..	

Gear VHZ..	
Dynamic diaphragm XF..	

Device Configurator ECI-1



- Can be used on site for:
 - parameter modification
 - firmware update
 - adjustment of inputs and outputs
- Can be connected via USB

Characteristics

The device configurator ECI-1 is an interface which allows the connection of microcontroller-managed HONSBERG sensors to the USB port of a computer. Together with the Windows software "HONSBERG Device Configurator" it enables

- the modification of all the sensor's configuration settings
- the reading of measured values
- the adjustment of inputs and outputs
- firmware updates

Technical data

Supply voltage	12..30 V DC (depending on the connected sensor) and via USB
Power consumption	< 1 W
Connection	
Sensor	cable bushing M12x1, 5-pole, straight length approx. 50 cm
Lead	device connector M12x1, 5-pole
USB	USB bushing type B
Operating temperature	0..50 °C
Storage temperature	-20..+80 °C
Dimensions of housing	98 mm (L) x 64 mm (W) x 38 mm (H)
Housing material	ABS
Ingress protection	IP 40

Handling and operation

Connection



The device configurator is intended for temporary connection to the application. It is connected between the the existing sensor lead and the sensor. Power supply is via the supply to the sensor and the computer's USB port. When inactive (no communication), the configurator behaves completely neutrally; all signals from the sensor remain available to the application. During communication between computer and sensor, the signal wirings are separated in the configurator, so that in this state the sensor's output signals are not available.

To connect 4-pole leads without a middle hole to the installed 5-pole device connector, adapter K04-05 is included. 4-pole leads with a middle hole can be used without an adapter.

Ordering code

Device configurator (for scope of delivery, see the diagram below)	ECI-1
--	--------------

Scope of delivery

1. Device configurator ECI-1
2. USB cable
3. Adapter K04-05
4. Plug KB05G
5. Cable K05PU-02SG
6. Carrying case



Incl. software

Accessories:

Mains connector 24 V DC (with fitted round plug connector, 5-pole, incl. international plug set)	EPWR24-1
--	-----------------



Replacement parts:

M12x1 adapter 4- / 5-pole	K04-05
PUR cable, 5-pole, shielded with round plug connector M12x1	K05PU-02SG
Round plug connector M12x1, 5-pole (without cable)	KB05G

Option

LABO transmitter - Temperature up to 150 °C



All LABO transmitters can be used with electronics positioned in a separate area with media temperatures up to 150 °C.

OMNI - Tropical model



This OMNI electronic option should be used where temperatures change quickly, or for external installations (the device is filled with oil, and thus prevents condensate formation in the electronics housing, even under adverse circumstances)

Accessories

Filter

Type ZV



Type ZE



The HONSBERG filters are offered for the protection of the devices from dirt or as independent components for coarse and fine filtration of liquids.

For more information, see additional product information.

Round plug connector 4 / 5-pin



Ordering code

Self-assembly

1. 2.

KB

1. Number of pins	
04	4-polig
05	5-polig
2. Steckerabgang	
G	gerade
W	gewinkelt 90 °

Panel meter OMNI-TA

Primary Sensors
0..10 V
4..20 mA
Frequency



Converter with the same data as the OMNI in situ electronics; but as an external panel-mounting variant with IP 67 housing.

OMNI - Remote

Primary Sensors
0/2..10 V
4/0..20 mA
Frequency



Function is identical to OMNI-in situ. Connection to the sensor is, however, made by wire, and so the measurement point and display location can be apart

contact us



Headquarter

GHM Messtechnik GmbH
GHM GROUP CORPORATE
 Tenter Weg 2-8
 42897 Remscheid | GERMANY
 Phone +49 2191 9672-0
 info@ghm-group.de
 www.ghm-group.de

Centers of Competences

GHM Messtechnik GmbH
GHM GROUP – Greisinger
 Hans-Sachs-Straße 26
 93128 Regenstauf | GERMANY
 Phone +49 9402 9383-0
 info@greisinger.de | www.greisinger.de

GHM Messtechnik GmbH
GHM GROUP – Honsberg
 Tenter Weg 2-8
 42897 Remscheid | GERMANY

GHM Messtechnik GmbH
GHM GROUP – Martens
 Kiebitzhörn 18
 22885 Barsbüttel | GERMANY

GHM Messtechnik GmbH
GHM GROUP – Imtron
 Carl-Benz-Straße 11
 88696 Owingen | GERMANY

Delta OHM S.r.l. a socio unico
GHM GROUP – Delta OHM
 Via Marconi 5
 35030 Caselle di Selvazzano
 Padova (PD) | ITALY
 Phone +39 049 8977150
 info@deltaohm.com
 www.deltaohm.com

Valco srl
GHM GROUP – VAL.CO
 Via Rovereto 9/11
 20014 S. Ilario di Nerviano
 Milano (MI) | ITALY
 Phone +39 0331 53 59 20
 valco@valco.it
 www.valco.it

GHM GROUP International

Austria
 GHM Messtechnik GmbH
 Office Austria
 Breitenseer Str. 76/1/36
 1140 Vienna | AUSTRIA
 Phone +43 660 7335603
 a.froestl@ghm-messtechnik.de

Brazil & Latin America
 GHM Messtechnik do Brasil Ltda
 Av. José de Souza Campos, 1073, cj 06
 Campinas, SP
 13025 320 | BRAZIL
 Phone +55 19 3304 3408
 info@grupoghm.com.br

Czech Republic / Slovakia
 GHM Greisinger s.r.o.
 Ovcí hajek 2/2153
 158 00 Prague 5
 Nove Butovice | CZECH REPUBLIC
 Phone +420 251 613828
 Fax +420 251 612607
 info@greisinger.cz | www.greisinger.cz

Denmark
 GHM Maaleteknik ApS
 Maarslet Byvej 2
 8320 Maarslet | DENMARK
 Phone +45 646492-00
 Fax +45 646492-01
 info@ghm.dk | www.ghm.dk

France
 GHM GROUP France SAS
 Parc des Pivolles
 9 Rue de Catalogne
 69150 Décines-Charpieu (Lyon) | FRANCE
 Phone +33 4 72 37 45 30
 contact@ghm-group.fr

India
 GHM Messtechnik India Pvt Ltd.
 209 | Udyog Bhavan | Sonowala Road
 Gregaon (E) | Mumbai - 400 063
 INDIA
 Phone +91 22 40236235
 info@ghmgroup.in | www.ghmgroup.in

Italy for Greisinger & Delta OHM
 GHM GROUP – Delta OHM
 Via Marconi 5
 35030 Caselle di Selvazzano
 Padova (PD) | ITALY
 Phone +39 049 8977150
 a.casati@ghm-messtechnik.de

Italy for Honsberg, Martens, Valco
 GHM GROUP – Valco
 Via Rovereto 9/11
 20014 S. Ilario di Nerviano
 Milano (MI) | ITALY
 Phone +39 0331 53 59 20
 alessandro.perego@valco.it

Netherlands
 GHM Meettechnik BV
 Zeeltweg 30
 3755 KA Eemnes | NETHERLANDS
 Phone +31 35 53805-40
 Fax +31 35 53805-41
 info@ghm-nl.com | www.ghm-nl.com

South Africa
 GHM Messtechnik SA (Pty) Ltd
 16 Olivier Street
 Verwoerdpark, Alberton 1453
 SOUTH AFRICA
 Phone +27 74 4590040
 j.grobler@ghm-sa.co.za

...and more than
100 qualified distributors!



Visit us at: www.ghm-group.de