

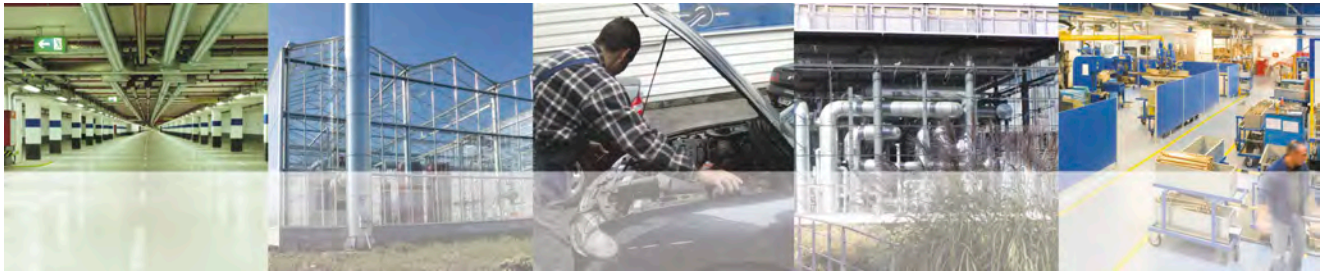

Product information
**Flow – Magnetic Inductive,
Inline Design**



Characteristics

System

- Magnetic inductive metering system for all conductive fluids.

Evaluation

- Display, switching, Metering, counting

Nominal widths

- DN 8..25

Range

- 0,05..60 l/min

Medien

- Non-aggressive, conductive fluids

Pressure resistance

- Max. 10 bar

Medium temperature

- 0..+60 °C

Function and benefits

„Magnetic inductive flow measurement technology“ has been successfully used in industrially applications for years. Previously, however, the technology was too expensive for simpler applications.

Now the benefits of this technology are also available for simpler applications:

- No moving parts in the flow area
- Minimal influence in the flow cross-section, resulting in minimal pressure loss from the sensor.
- Brass is independent of temperature, viscosity, concentrations and pressure
- Chemical compatibility only depends on the resistance of the electrodes and the measurement tube
- Resistant to foreign objects which are carried along in the liquid
- Laminar or turbulent flows are measured similarly

Limitations:

- Only conductive materials (at least 50 $\mu\text{S}/\text{cm}$) can be measured. Air pockets negatively influence the measurement (therefore steam phases cannot be measured)
- Deposits on the electrodes or in the measurement tube can cause measurement errors

In order to meet the various requirements of our customers, the magnetic-inductive flow meter MID1 is offered as an entire family of products.

Applications

- Metering of present value
- Totalisation
- Batch counting, filling applications
- Consumption metering
- Dry-run protection

HONSBERG provides customers with what they need. With the modular system, customer requests are configured and not developed specifically for the customer.

You can search for the right converter on the primary sensor.

- With LABO-MID1-F, you can request any arbitrary frequency (max. 2 kHz) in the beginning and end zones (advantageous with the use of turbines. You can directly replace the frequency of the turbines)
- With LABO-MID1-I or LABO MID1-U, you have the possibility of selecting analog currents or even voltages proportional to the flow of your PLC.
- LABO-MID1-S gives you the opportunity to directly program a switching point (if necessary, also with power-on delay, power-off delay, special hystereses, etc.)
- The FLEX electronics have an analog and a universally and programmable switching output.
- The OMNI electronics offer you all the capability of a complete transmitter and switch with graphics-capable display, which you can read in bright daylight or in darkness, provided in clear text, not hieroglyphics.

How does a magnetic inductive flow meter work?

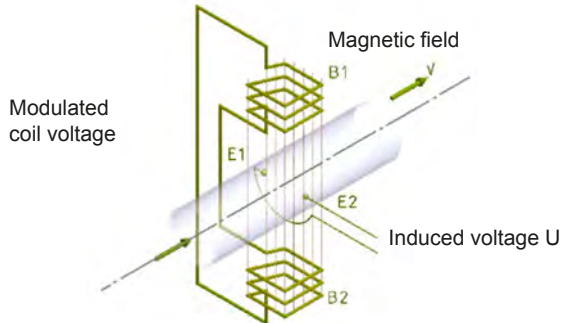

An inductive flow sensor is comprised of an electromagnet and two electrodes which are insulated from the measurement tube. If a liquid flows through the measurement tube, the voltage U can be tapped at the two electrodes ($E1$ and $E2$) opposite and perpendicular to the flow (see diagram) in accordance with Faraday's law of induction. For a rotation-symmetric flow profile and a homogeneous magnetic field, this voltage is directly proportional to the average flow speed v (k : proportional factor):

$$U = k \cdot B \cdot D \cdot v$$

The flow Q can be determined from the tube cross-section D and the average flow speed v :

$$Q = \frac{\pi \cdot D^2}{4} \cdot v = \frac{\pi \cdot D}{4k \cdot B} \cdot U$$

With this process, an electric signal can be taken directly from the flow and processed. For both laminar and turbulent flows there is a strong linear relationship between the flow speed v and the induced voltage U .

Characteristics of the present sensors

The process used here operates with a cycled direct current field and can suppress arising interference voltages by computer. The square flow guide minimises the rotation of the flow in the measurement channel and thereby enables a somewhat problem-free flow guidance upstream from the sensor. The electrodes are wand-shaped and thus guarantee a high level of leak resistance on pressure surges as well as self-cleaning with the flow.

Please observe the instructions in the technical data sheets and the MID1... will provide you long and constant precision over its service life.

On the spot programming options

MID1



Pulse programming on PIN 2
Apply 24 V DC for one second and save the present value as the final value (for analog outputs) or as a switching value (for limit value).

OMNI-MID1...



Programming with Magnet-Ring:
With the aid of the display and of the movable ring, numerous parameters can be conveniently set on the spot.

FLEX-MID1...



Programming with Magnet-Clip:
Hold the magnet to the marking for 1 second and save the present value as the full scale value (for analog outputs) or as a switching value (for limit switches).

ECI-1



If required, all parameters can be set at any time on all intelligent sensors, using the ECI-1 device configurator.

Device overview

Device	Range	Nominal width	Pressure resistance in bar	Medium temperature	Supply voltage	Displays	Output signal		Page
							Switching	Measuring	
MID1	0,05..60 l/min	DN 8..25	PN 10	0..+60 °C	12..24 V DC	Signal LED	-	Frequency 0..400 Hz NPN OC	5
LABO-MID1-S	0,05..60 l/min	DN 8..25	PN 10	0..+60 °C	10..30 V DC	Signal LED	1 x Push-pull	-	7
LABO-MID1-I	0,05..60 l/min	DN 8..25	PN 10	0..+60 °C	10..30 V DC	Signal LED	-	4..20 mA	10
LABO-MID1-U	0,05..60 l/min	DN 8..25	PN 10	0..+60 °C	10..30 V DC	Signal LED	-	0..10 V	10
LABO-MID1-F	0,05..60 l/min	DN 8..25	PN 10	0..+60 °C	10..30 V DC	Signal LED	-	Frequenz 0..2 kHz	10
LABO-MID1-C	0,05..60 l/min	DN 8..25	PN 10	0..+60 °C	10..30 V DC	Signal LED	-	Puls / Menge	10
FLEX-MID1	0,05..60 l/min	DN 8..25	PN 10	0..+60 °C	18..24 V DC	Signal LED	1 x Push-Pull or frequency 0..2 kHz	0/4..20 mA or 0..10 V	13
OMNI-MID1	0,05..60 l/min	DN 8..25	PN 10	0..+60 °C	18..24 V DC	Signal LED	2 x Push-pull	0/4..20 mA or 0..10 V	17
Counter-OPTION-C	Preset Counter with external reset facility, anti-complementary switching outputs and actual value display.								21
ECI-1	All LABO, FLEX, and OMNI parameters can be set or modified using the ECI-1 configurator.								24
Option	○ OMNI – Tropical model								25
Accessories	<ul style="list-style-type: none"> ○ Type ZV / ZE (Filter) ○ KB.... (Round plug connector 4/5-pin) ○ OMNI-TA (Panel meter) ○ OMNI-remote 								25 25 26 27

Errors and technical modifications reserved.

Flow Transmitter MID1



- For all electrically conductive fluids
- Fixed frequency output range as signal
- No moving parts in the area of flow
- High medium overload safety
- Low pressure loss
- Compact design

Characteristics

The MID1 system consists of a number of sensors which measure the flow speed of a flowing fluid according to the principle of Faraday's law of induction. For this, the fluid must have a minimum electrical conductivity of 50 µS/cm.

Three nominal widths are available. The sensors are available with different evaluation electronics, which vary in type and number of outputs, and in operating convenience.

This transmitter has a non-programmable frequency output (400 Hz at full scale value).

Technical data

Sensor	magnetic-inductive	
Nominal width	DN 8..25	
Process connection	male thread R 1/4", R 1/2", R 1"	
Metering ranges	0.05..60 l/min	for details, see table "Ranges"
Measurement accuracy	0.05..1.5 l/min	
Repeatability	1 %	
Minimum electrical conductivity (medium)	50 µS/cm	
Pressure resistance	PN 10 bar	
Pressure loss	max. 0.3 bar at max. flow	
Medium temperature	0..60 °C (avoid frost and dew)	
Ambient temperature	0..60 °C	
Storage temperature	-20..+80 °C	
Materials medium-contact	stainless steel 1.4404, PPS, FKM	
Supply voltage	12..24 V DC	
Current consumption	approx. 100 mA	

Signal output	NPN o.c., 400 Hz at full scale value	
Electrical connection	for round plug connector M12x1, 4-pole	
Ingress protection	IP 64	
Weight	R 1/4"	approx. 0.2 kg
	R 1/2"	approx. 0.2 kg
	R 1"	approx. 0.3 kg
Conformity	CE	

Ranges

R	Nominal width	Metering range l/min H2O	Measurement accuracy
R 1/4"	DN 8	0.05.. 1	2.5 % of the measured value, at least 0.005 l/min
R 1/2"	DN 15	0.50..10	2.5 % of the measured value, at least 0.05 l/min
R 1"	DN 25	3.00..60	2.5 % of the measured value, at least 0.3 l/min

Wiring

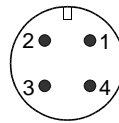
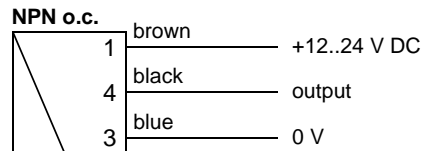

Before the electrical installation, it must be ensured that the supply voltage corresponds with the data sheet. It is recommended to use shielded wiring.

Dimensions

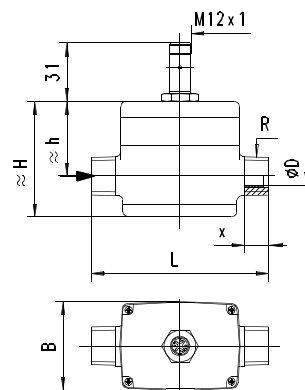

R	Types	L mm	H mm	h mm	x mm	B mm	D mm
R 1/4"	MID1-008	85	59	39	9	47	5
R 1/2"	MID1-015	95	63	42	13	47	10
R 1"	MID1-025	110	72	45	16	49	20

Handling and Operation

Installation

The device is screwed into the pipework by means of two male threads or into suitable connection pieces. Here, attention must be paid to the direction (arrow marked on the housing in the direction of flow). Seal using Teflon tape or a fluid seal.

Use the following torques:

R 1/4 ":	3 ±0.5 Nm
R 1/2 "	5 ±0.5 Nm
R 1	12 ±1.0 Nm

The sensor can be operated in any location. However, air bubbles should be avoided. Direction of flow from bottom to top is recommended.

The electronics head is supplied mounted on the sensor body.

Avoid angular loading of the sensor. Pipework in which sensors are installed should be permanently flooded. 10 x D should be used in the inlet and outlet.

Programming

The setting of this transmitter has been fixed in the factory. Changes of parameters must be requested from HONSBERG.

Ordering code

MID1- 1. 2. **A** 3. **P** 4. 5. **M** 6. **S** 7.

○=Option

1. Nominal width	
008	DN 8 - R 1/4 "
015	DN 15 - R 1/2 "
025	DN 25 - R 1 "
2. Process connection	
A	male thread
3. Housing material	
P	PPS
4. Metering range	
001	0.05.. 1 l/min
010	0.50..10 l/min
060	3.00..60 l/min
5. Signal output	
M	frequency output NPN o.c.
6. Electrical connection	
S	for round plug connector M12x1, 4-pole
7. Filter time	
	Filter Accuracy
01	○ 0.1 s ± 4.2 %
03	○ 0.3 s ± 3.6 %
06	○ 0.6 s ± 3.1 %
10	○ 1.0 s ± 2.7 %
20	2.0 s ± 2.0 %
40	○ 4.0 s ± 0.5 %

of the full scale value

Options

- Housing material PEEK

Accessories

- Cable/round plug connector (KB...) see additional information "Accessories"

Flow Transmitter LABO-MID1-S



- For all electrically conductive fluids
- No moving parts in the area of flow
- High overload protection
- Low pressure loss
- Compact design
- Various nominal widths

Characteristics

The MID1 system consists of a number of sensors which measure the flow speed of a flowing fluid according to the principle of Faraday's law of induction. For this, the fluid must have a minimum electrical conductivity of 50 µS/cm. The speed is converted to a flow quantity in proportion to the cross-section of the measurement pipe. Three nominal widths are available. The sensors are available with different converter / counter, which vary in type and number of outputs, and in operating convenience.

The LABO electronics fitted to the device make available an electronic switching output (push-pull) with adjustable characteristics (minimum/maximum) and hysteresis, which responds when an adjustable limit is fallen short of or exceeded. If desired, the switching value can be set to the currently existing flow using "teaching". Models with analog or pulse output are also available (see separate data sheets).

Technical data

Sensor	magnetic-inductive	
Nominal width	DN 8..25	
Process connection	Male thread R 1/4", R 1/2", R 1"	
Switching ranges	0.05.. 60 l/min	For details, see table "Ranges"
Measurement accuracy	0.05..1.5 l/min	
Electrical Minimum conductivity (medium)	50 µS/cm	
Pressure resistance	PN 10 bar	
Pressure loss	max. 0.3 bar at max. flow	
Medium temperature	0..60 °C (avoid frost and dew)	
Operating temperature	0..70 °C (Electronics)	
Storage temperature	-20..+80 °C	

Materials medium-contact	stainless steel 1.4404, PPS, FKM	
Materials, non-medium-contact	Sensor tube:	CW614N nickelled
	Adhesive:	Epoxy resin
Supply voltage	18..30 V DC	
Power consumption	< 1 W (for no-load output)	
Switching output	transistor output "push-pull" (resistant to short circuits and polarity reversal) I _{out} = 100 mA max.	
Display	yellow LED (On = Normal / Off = Alarm / rapid flashing = Programming)	
Electrical connection	for round plug connector M12x1, 4-pole	
Ingress protection	IP 64	
Weight	R 1/4"	approx. 0.2 kg
	R 1/2"	approx. 0.2 kg
	R 1"	approx. 0.3 kg
Conformity	CE	

Ranges

R	Nominal width	Metering range l/min H2O	Measurement accuracy
R 1/4"	DN 8	0.05.. 1	2.5 % of the measured value, at least 0.005 l/min
R 1/2"	DN 15	0.50..10	2.5 % of the measured value, at least 0.05 l/min
R 1"	DN 25	3.00..60	2.5 % of the measured value, at least 0.3 l/min

Wiring

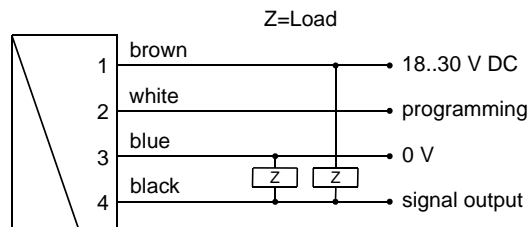

Connection example: PNP NPN

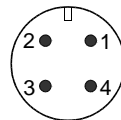

Before the electrical installation, it must be ensured that the supply voltage corresponds to the data sheet. It is recommended to use shielded wiring. The push-pull output) can as desired be switched as a PNP or an NPN output.

Dimensions

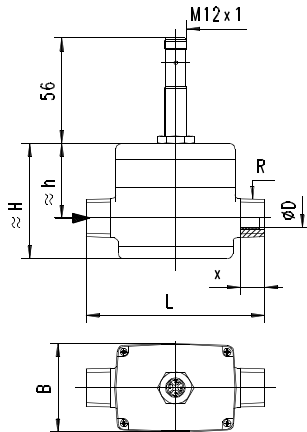

R	Types	L mm	H mm	h mm	x mm	B mm	D mm
R 1/4"	MID1-008	85	59	39	9	47	5
R 1/2"	MID1-015	95	63	42	13	47	10
R 1"	MID1-025	110	72	45	16	49	20

Handling and operation

Installation

The device is screwed into the pipework by means of two male threads or into suitable connection pieces. Here, attention must be paid to the direction (arrow marked on the housing in the direction of flow). Seal using Teflon tape or a fluid seal.

Use the following torques:

- R 1/4": 3 ±0.5 Nm
- R 1/2": 5 ±0.5 Nm
- R 1": 12 ±1.0 Nm

The sensor can be operated in any location. However, air bubbles should be avoided. Direction of flow from bottom to top is recommended.

Avoid angular loading of the sensor. Pipework in which sensors are installed should be permanently flooded. 10 x D should be used in the inlet and outlet.

Note

The switching value is programmed by the user via "teaching". If desired, programmability can be blocked by the manufacturer. The ECI-1 device configurator with associated software is available as a convenient option for programming all parameters by PC, and for adjustment.

Operation and programming

The switching value is set as follows:

- Apply the flow rate to be set to the device.
- Apply an impulse of at least 0.5 seconds and max. 2 seconds duration to pin 2 (e.g. via a bridge to the supply voltage or a pulse from the PLC), in order to accept the measured value.
- When the teaching is complete, pin 2 should be connected to 0 V, so as to prevent unintended programming.

The device has a yellow LED which flashes during the programming pulse. During operation, the LED serves as a status display for the switching output.

In order to avoid the need to transit to an undesired operating status during the teach-in, the device can be provided ex-works with a teach-offset. The teach-offset point is added to the currently measured value before saving. The offset point can be positive or negative.

Example: The switching value should be set to 80 %. However, it is possible only to reach 60 % without problems. In this case, the device would be ordered with a "teach-offset" of +20%. At a flow rate of 60 % in the process, teaching would then store a value of 80 %.

The limit switch can be used to monitor minimal or maximal.

With a minimum-switch, falling below the limit value causes a switchover to the alarm state. Return to the normal state occurs when the limit value plus the set hysteresis is once more exceeded.

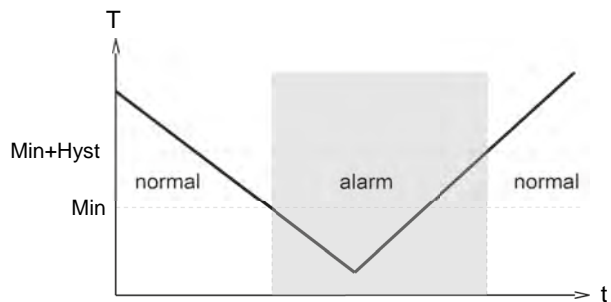

With a maximum-switch, exceeding the limit value causes a switchover to the alarm state. Return to the normal state occurs when the measured value once more falls below the limit value minus the set hysteresis.

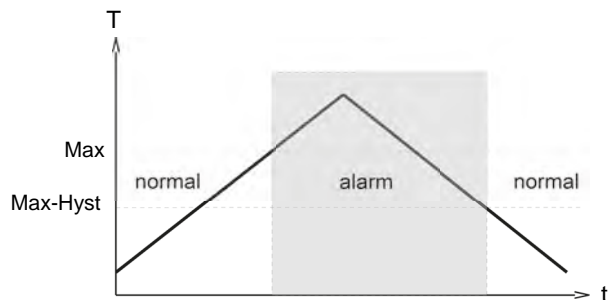

A switchover delay time (t_{DS}) can be applied to the switchover to the alarm state. Equally, one switch-back delay time (t_{DR}) of several can be applied to switching back to the normal state.

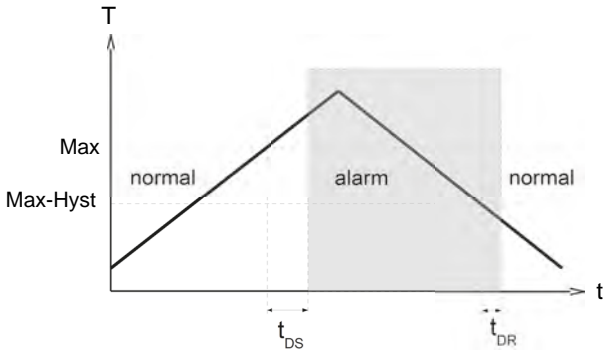

In the normal state the integrated LED is on, in the alarm state it is off, and this corresponds to its status when there is no supply voltage.

In the non-inverted (standard) model, while in the normal state the switching output is at the level of the supply voltage; in the alarm state it is at 0 V, so that a wire break would also display as an alarm state at the signal receiver. Optionally, an inverted switching output can also be provided, i.e. in the normal state the output is at 0 V, and in the alarm state it is at the level of the supply voltage.

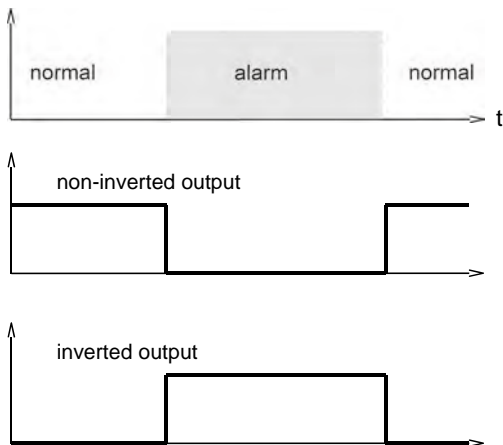

A Power-On-Delay function (ordered as a separate option) makes it possible to maintain the switching output in the normal state for a defined period after application of the supply voltage.

Ordering code

The basic device is ordered e.g. MID1-xxx with electronics e.g. LABO-MID-xxx

MID1- 1. 2. **A** 3. **P** 4. 5. **E**

LABO- MID1- 6. 7. **S** 8. 9. 10. 11. **S**

○=Option

1. Nominal width			
008	DN 8 - R 1/4"		
015	DN 15 - R 1/2"		
025	DN 25 - R 1"		
2. Process connection			
A	male thread		
3. Housing material			
P	PPS		
4. Switching range			
001	0.05.. 1 l/min		•
010	0.50..10 l/min		•
060	3.00..60 l/min	•	
5. Connection for			
E	electronics		
6. For nominal width			
008	DN 8 - R 1/4"		•
015	DN 15 - R 1/2"		•
025	DN 25 - R 1"	•	
7. Switching output (Limit switch)			
S	push-pull (compatible with PNP and NPN)		
8. Programming			
P	programmable (teaching possible)		
N	<input type="radio"/> cannot be programmed (no teaching)		
9. Switching function			
L	minimum-switch		
H	maximum-switch		
10. Switching signal			
O	standard		
I	<input type="radio"/> inverted		
11. Electrical connection			
S	for round plug connector M12x1, 4-pole		

Flow Transmitter LABO-MID1-I / U / F / C



- For all electrically conductive fluids
- Electrical outputs configurable (4..20 mA, 0..10 V, frequency, pulse / x l / min)
- No moving parts in the area of flow
- High overload protection
- Low pressure loss
- Compact design
- 0..10 V , 4..20 mA , frequency/pulse output, completely configurable.

Characteristics

The MID1 system consists of a number of sensors which measure the flow speed of a flowing fluid according to the principle of Faraday's law of induction. For this, the fluid must have a minimum electrical conductivity of 50 µS/cm. The speed is converted to a flow quantity in proportion to the cross-section of the measurement pipe. Three nominal widths are available.

The sensors are available with different evaluation electronics, which vary in type and number of outputs, and in operating convenience.

The LABO electronics make various output signals available:

- Analog signal 0/4..20 mA (LABO-I)
- Analog signal 0/2..10 V (LABO-U)
- Frequency signal (LABO-F) or
- A value signal Pulse / x Litres (LABO-C)

A model with switching output is also available.

If desired, the range end value can be set to the currently existing flow using "teaching".

Technical data

Sensor	magnetic-inductive	
Nominal width	DN 8..25	
Process connection	male thread R 1/4", R 1/2", R 1"	
Metering ranges	0.05..60 l/min	for details, see table "Ranges"
Measurement accuracy	0.05..1.5 l/min	
Electrical Minimum conductivity (medium)	50 µS/cm	
Pressure resistance	PN 10 bar	
Pressure loss	max. 0.3 bar at max. flow	
Medium temperature	0..+60 °C (avoid frost and dew)	
Operating temperature	0..+70 °C (Electronics)	
Storage temperature	-20..+80 °C	
Materials medium-contact	stainless steel 1.4404, PPS, FKM	
Materials, non-medium-contact	Sensor tube:	CW614N nickelled
	Adhesive:	Epoxy resin
Supply voltage	18..30 V DC	
Power consumption	< 1 W (for no-load outputs)	
Output data:	all outputs are resistant to short circuits and reversal polarity protected	
Current output:	4..20 mA (0..20 mA available on request)	
Voltage output:	0..10 V (2..10 V available on request)	
Frequency output:	output current max. 20 mA	
Pulse output:	Transistor output "push-pull"	
	I _{out} = 100 mA max.	
	transistor output "push-pull"	
	I _{out} = 100 mA max.	
	pulse width 50 ms	
	pulse per volume is to be stated	
Display	yellow LCD shows operating voltage (LABO-XF-I / U) or output status (LABO-XF-F / C) or (rapid flashing = Programming)	
Electrical connection	for round plug connector M12x1, 4-pole	
Ingress protection	IP 64	
Weight	R 1/4"	approx. 0.2 kg
	R 1/2"	approx. 0.2 kg
	R 1"	approx. 0.3 kg
Conformity	CE	

Signal output curves

Value x = Begin of the specified range
 = not specified range

Current output

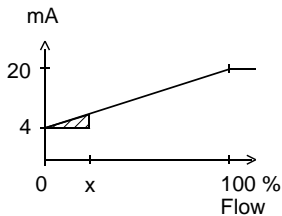

Voltage output

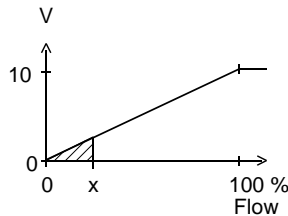

Frequency output

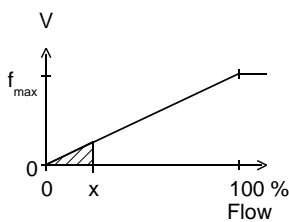

f_{max} selectable in the range of up to 2000 Hz

Other characters on request.

Ranges

R	Nominal width	Metering range l/min H ₂ O	Measurement accuracy
R 1/4"	DN 8	0.05.. 1	2.5 % of the measured value, at least 0.005 l/min
R 1/2"	DN 15	0.50..10	2.5 % of the measured value, at least 0.05 l/min
R 1"	DN 25	3.00..60	2.5 % of the measured value, at least 0.3 l/min

Wiring

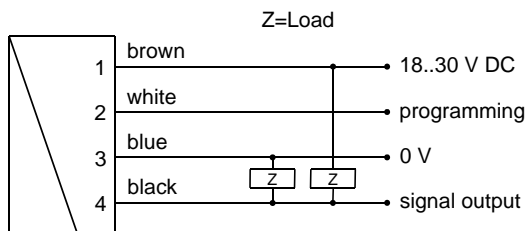

Connection example: PNP NPN

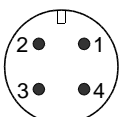

Before the electrical installation, it must be ensured that the supply voltage corresponds to the data sheet. It is recommended to use shielded wiring.

The push-pull output) of the frequency output version can as desired be switched as a PNP or an NPN output.

Dimensions

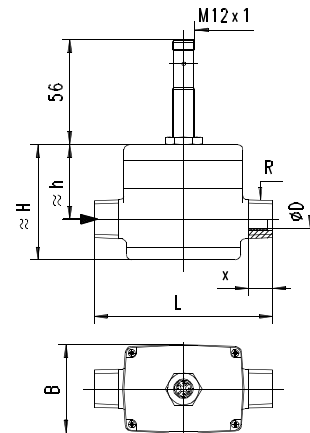

R	Types	L mm	H mm	h mm	x mm	B mm	D mm
R 1/4"	MID1-008	85	59	39	9	47	5
R 1/2"	MID1-015	95	63	42	13	47	10
R 1"	MID1-025	110	72	45	16	49	20

Handling and operation

Installation

The device is screwed into the pipework by means of two male threads or into suitable connection pieces. Here, attention must be paid to the direction (arrow marked on the housing in the direction of flow). Seal using Teflon tape or a fluid seal.

Use the following torques:

- R 1/4": 3 ±0.5 Nm
- R 1/2": 5 ±0.5 Nm
- R 1: 12 ±1,0 Nm

The sensor can be operated in any location. However, air bubbles should be avoided. Direction of flow from bottom to top is recommended.

Avoid angular loading of the sensor. Pipework in which sensors are installed should be permanently flooded. 10 x D should be used in the inlet and outlet.

Note

The metering range end value can be programmed by the user via "teaching". Requirement for programmability must be stated when ordering, otherwise the device cannot be programmed.

The ECI-1 device configurator with associated software is available as a convenient option for programming all parameters by PC, and for adjustment.

The teaching option is not available for the pulse output version.

Operation and programming

- The teaching process can be carried out by the user as follows:
- The measured value which is to be set is applied to the device.
 - Apply an impulse of at least 0.5 seconds and max. 2 seconds duration to pin 2 (e.g. via a bridge to the supply voltage or a pulse from the PLC), in order to accept the measured value.
 - When the teaching is complete, pin 2 should be connected to 0 V, so as to prevent unintended programming.

The devices have a yellow LED which flashes during the programming pulse. During operation, the LED serves as an

indicator of operating voltage (for analog output) or of switching status (for frequency or pulse output).

In order to avoid the need to transit to an undesired operating status during the teach-in, the device can be provided ex-works with a teach-offset. The teach-offset point is added to the currently measured value before saving. The offset point can be positive or negative.

Example: The end of the metering range should be set to 80 %. However, only 60 % can be achieved without problem. In this case, the device would be ordered with a "teach-offset" of +20 %. At a flow rate of 60 % in the process, teaching would then store a value of 80 %.

There are many more parameters which can be programmed by the ECI-1 device configurator if necessary.

Ordering code

The basic device is ordered e.g. MID1-xxx with electronics e.g. LABO-MID-xxx

MID1- 1. 2. 3. 4. 5. **A** **P** **E**

LABO- MID1- 6. 7. 8. 9.

○=Option

1. Nominal width				
008	DN 8 - R 1/4 "			
015	DN 15 - R 1/2 "			
025	DN 25 - R 1 "			
2. Process connection				
A	male thread			
3. Housing material				
P	PPS			
4. Metering range				
001	0.05.. 1 l/min			●
010	0.50..10 l/min			●
060	3.00..60 l/min		●	
5. Connection for				
E	electronics			
6. For nominal width				
008	DN 8 - R 1/4 "			●
015	DN 15 - R 1/2 "			●
025	DN 25 - R 1 "		●	
7. Signal output				
I	current output 4..20 mA			
U	voltage output 0..10 V			
F	frequency output			
C	pulse output			
8. Programming				
P	<input type="radio"/> programmable (teaching possible)			
N	<input type="radio"/> cannot be programmed (no teaching)			
9. Electrical connection				
S	for round plug connector M12x1, 4-pole			

Required ordering information

For LABO-MID1-F:

Output frequency at full scale Hz
Maximum value: 2,000 Hz

For LABO-MID1-C:

For the pulse output version, the volume (with numerical value and unit) which will correspond to one pulse must be stated.

Volume per pulse (numerical value)

Volume per pulse (unit)

Options for LABO

Special range for analog output:

<= Metering range (Standard=Metering range) l/min

Special range for frequency output:

<= Metering range (Standard=Metering range) l/min

Power-On delay period (0..99 s)

s
(time after applying power during which the outputs are not activated or set to defined values)

Further options available on request.

Options

- Housing material PEEK

Accessories

- Cable/round plug connector (KB...) see additional information "Accessories"
- Evaluation electronics OMNI-TA
- Device configurator ECI-1

Flow Transmitter FLEX-MID1



- For all electrically conductive fluids
- No moving parts in the area of flow
- Analog output (4..20 mA or 0..10 V)
- 1 x switching output (push-pull) or widely programmable frequency output
- High overload protection
- Low pressure loss
- Compact design

Characteristics

The MID1 system consists of a number of sensors which measure the flow speed of a flowing fluid according to the principle of Faraday's law of induction. For this, the fluid must have a minimum electrical conductivity of 50 µS/cm. Three nominal widths are available. The sensors are available with different evaluation electronics, which vary in type and number of outputs, and in operating convenience.

The FLEX transducer on the sensor has an analog output (4..20 mA or 0..10 V) and one switching output, which can be configured as a limit switch for monitoring minimal or maximal, or as a frequency output.

The switching output is designed as a push-pull driver, and can therefore be used both as a PNP or an NPN output. The state of the switching output is signalled with a yellow LED in the switching outlet; the LED has all-round visibility.

The sensor is configured in the factory, or alternatively this can be done with the aid of the optionally available ECI-1 device configurator (USB interface for PC). A selectable parameter can be modified on the device, with the aid of the magnet clip provided. In this case, the current measured value is saved as the parameter value. Examples of these parameters are the switching value or the metering range end value.

The stainless steel electronics housing is rotatable, so it is possible to orient the cable outlet after installation.

Technical data

Sensor	magnetic-inductive	
Nominal width	DN 8..25	
Process connection	male thread R 1/4", R 1/2", R 1"	
Metering ranges	0.05..60 l/min	for details, see table "Ranges"
Measurement accuracy	0.05..1.5 l/min	
Repeatability	1 %	
Electrical Minimum conductivity (medium)	50 µS/cm	
Pressure resistance	PN 10 bar	
Pressure loss	max. 0.3 bar at max. flow	
Medium temperature	0..60 °C (avoid frost and dew)	
Ambient temperature	0..60 °C	
Storage temperature	-20..+80 °C	
Materials medium-contact	stainless steel 1.4404, PPS, FKM	
Materials, non-medium-contact	Electronic housing	Stainless steel 1.4305
	Connection plate	CW614N nickelled
Supply voltage	18..30 V DC	
Current consumption	approx. 120 mA	
Analog output	4..20 mA or 0..10 V DC	
Switching output	transistor output "push-pull" (resistant to short circuits and polarity reversal) $I_{out} = 100 \text{ mA max.}$	
Switching hysteresis	adjustable (please state when ordering)	
Display	yellow LED (On = Normal / Off = Alarm)	
Electrical connection	for round plug connector M12x1, 4-pole	
Ingress protection	IP 64	
Weight	R 1/4"	approx. 0.32 kg
	R 1/2"	approx. 0.32 kg
	R 1"	approx. 0.42 kg
Conformity	CE	

Signal output curves

Value x = Begin of the specified range
 = not specified range

Current output

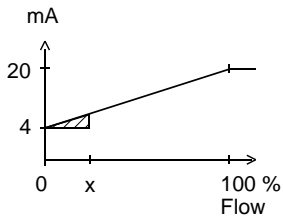

Voltage output

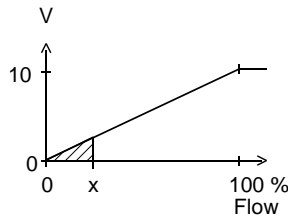

Frequency output

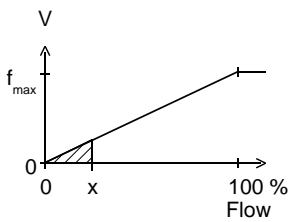

f_{max} selectable in the range of up to 2000 Hz

Other characters on request.

Ranges

R	Nominal width	Metering range l/min H2O	Measurement accuracy
R 1/4"	DN 8	0.05.. 1	2.5 % of the measured value, at least 0.005 l/min
R 1/2"	DN 15	0.50..10	2.5 % of the measured value, at least 0.05 l/min
R 1"	DN 25	3.00..60	2.5 % of the measured value, at least 0.3 l/min

Wiring

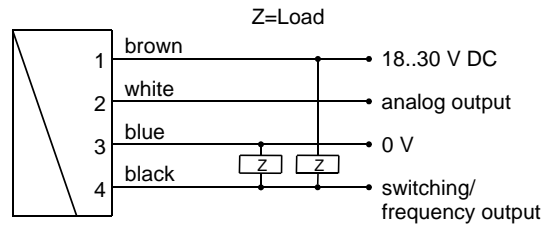

Connection example: PNP NPN

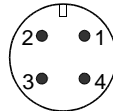

Before the electrical installation, it must be ensured that the supply voltage corresponds with the data sheet.

It is recommended to use shielded wiring. The push-pull output can as desired be switched as a PNP or an NPN output.

Dimensions

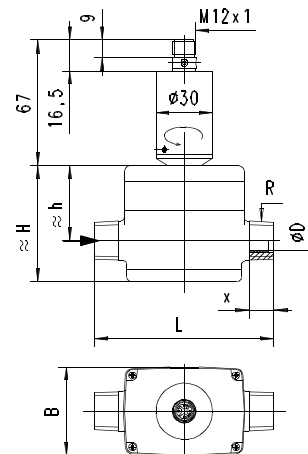

R	Types	L mm	H mm	h mm	x mm	B mm	D mm
R 1/4"	MID1-008	85	59	39	9	47	5
R 1/2"	MID1-015	95	63	42	13	47	10
R 1"	MID1-025	110	72	45	16	49	20

Handling and operation

Installation

The device is screwed into the pipework by means of two male threads or into suitable connection pieces. Here, attention must be paid to the direction (arrow marked on the housing in the direction of flow). Seal using Teflon tape or a fluid seal.

Use the following torques:

R 1/4 ":	3 ±0.5 Nm
R 1/2 ":	5 ±0.5 Nm
R 1:	12 ±1.0 Nm

The sensor can be operated in any location. However, air bubbles should be avoided. Direction of flow from bottom to top is recommended.

The electronics head is supplied mounted on the sensor body.

Avoid angular loading of the sensor. Pipework in which sensors are installed should be permanently flooded. 10 x D should be used in the inlet and outlet.

Programming

The electronics contain a magnetic contact, with the aid of which different parameters can be programmed. Programming takes place when a magnet clip is applied for a period between 0.5 and 2 seconds to the marking located on the label. If the contact time is longer or shorter than this, no programming takes place (protection against external magnetic fields).



After the programming ("teaching"), the clip can either be left on the device, or removed to protect data.

The device has a yellow LED which flashes during the programming pulse. During operation, the LED serves as a status display for the switching output.

In order to avoid the need to transit to an undesired operating status during "teaching", the device can be provided ex-works with a "teach-offset". The "teach-offset" value is added to the currently measured value before saving (or is subtracted if a negative value is entered).

Example: The switching value is to be set to 70 % of the metering range, because at this flow rate a critical process status is to be notified. However, only 50 % can be achieved without danger. In this case, the device would be ordered with a "teach-offset" of +20 %. At 50 % in the process, a switching value of 70 % would then be stored during "teaching".

Normally, programming is used to set the limit switch. However, if desired, other parameters such as the end value of the analog or frequency output may also be set.

The limit switch can be used to monitor minimal or maximal.

With a minimum-switch, falling below the limit value causes a switchover to the alarm state. Return to the normal state occurs when the limit value plus the set hysteresis is again exceeded.

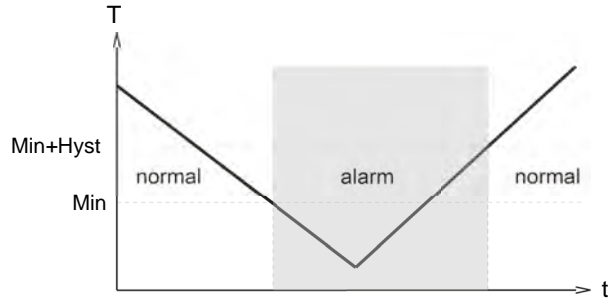

With a maximum-switch, exceeding the limit value causes a switchover to the alarm state. Return to the normal state occurs when the measured value once more falls below the limit value minus the set hysteresis.

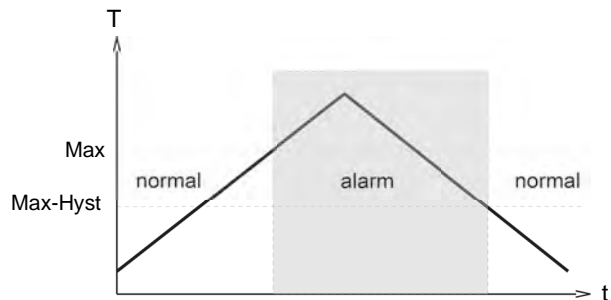

A switchover delay time (t_{DS}) can be applied to the switchover to the alarm state. Equally, one switch-back delay time (t_{DR}) of several can be applied to switching back to the normal state.

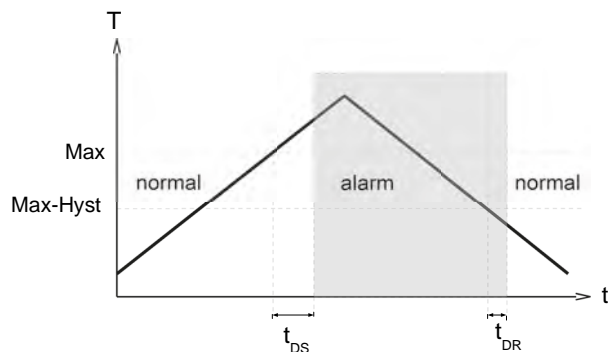

In the normal state the integrated LED is on, in the alarm state it is off, and this corresponds to its status when there is no supply voltage.

In the non-inverted (standard) model, while in the normal state the switching output is at the level of the supply voltage; in the alarm state it is at 0 V, so that a wire break would also display as an alarm state at the signal receiver. Optionally, an inverted switching output can also be provided, i.e. in the normal state the output is at 0 V, and in the alarm state it is at the level of the supply voltage.

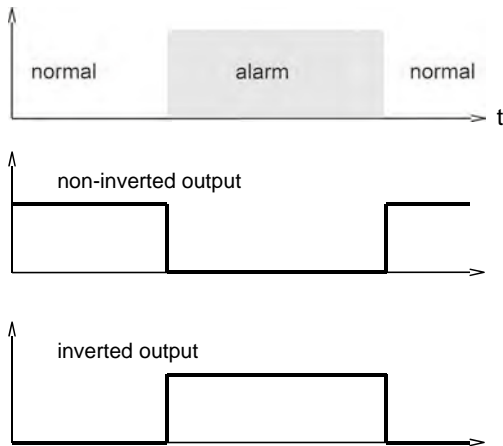

A Power-On delay function (ordered as a separate option) makes it possible to maintain the switching output in the normal state for a defined period after application of the supply voltage.

Ordering code

The basic device is ordered e.g. MID1-xxx with electronics e.g. FLEX-MID1-xxx

MID1- 1. 2. **A** 3. **P** 4. 5. **E**

FLEX-MID1- 6. 7. 8. 9.

○=Option

1. Nominal width	
008	DN 8 - R 1/4"
015	DN 15 - R 1/2"
025	DN 25 - R 1"
2. Process connection	
A	male thread
3. Housing material	
P	PPS
4. Metering range	
001	0.05.. 1 l/min
010	0.50.. 10 l/min
060	3.00.. 60 l/min
5. Connection for	
E	electronics
6. For nominal width	
008	DN 8 - R 1/4"
015	DN 15 - R 1/2"
025	DN 25 - R 1"
7. Analog output	
I	current output 4..20 mA
U	voltage output 0..10 V
8. Functioning of the switching output	
L	minimum switch
H	maximum switch
R	frequency output
9. Switching signal	
O	standard output
I	inverted output

Options for FLEX

Special range for analog output: l/min
(not greater than the sensor's working range)

Special range for frequency output: l/min
(not greater than the sensor's working range)

End frequency (max. 2000 Hz) Hz

Switching delay s
(from Normal to Alarm)

Switchback delay s
(from Alarm to Normal)

Power-On delay (0..99) s
(time after power on, during which the outputs are not actuated)

Switching output fixed l/min

Special hysteresis (standard = 2% EW) %

Options

- Housing material PEEK

Accessories

- Cable/round plug connector (KB...) see additional information "Accessories"
- Device configurator ECI-1

Flow Transmitter / Switch OMNI-MID1



- For all electrically conductive fluids
- No moving parts in the area of flow
- High overload protection
- Low pressure loss
- Analog output, two switching outputs
- Clear, easily legible, illuminated graphic LCD display
- Modifiable units in the display
- Small, compact construction

Characteristics

The MID1 system consists of a number of sensors which measure the flow speed of a flowing fluid according to the principle of Faraday's law of induction. For this, the fluid must have a minimum electrical conductivity of 50 µS/cm. Three nominal widths are available.

The sensors are available with different evaluation electronics, which vary in type and number of outputs, and in operating convenience.

The OMNI transducer located on the sensor has a backlit graphics LCD display which is very easy to read, both in the dark and in bright sunlight. The graphics display allows the presentation of measured values and parameters in a clearly understandable form. The measured values are displayed to 4 places, together with their physical unit, which may also be modified by the user. The electronics have an analog output (4..20 mA or 0..10 V) and two switching outputs, which can be used as limit switches for monitoring minimal or maximal, or as two-point controllers.

The switching outputs are designed as push-pull drivers, and can therefore be used both as PNP and NPN outputs. Exceeding limit values is signalled by a red LED which is visible over a long distance, and by a cleartext in the display. The stainless steel case has a hardened non-scratch mineral glass pane. It is operated by a programming ring fitted with a magnet, so there is no need to open the operating controls housing, and its leakproofness is permanently ensured.

By turning the ring to right or left, it is simple to modify the parameters (e.g. switching point, hysteresis...). To protect from unintended programming, it can be removed, turned through 180° and replaced, or completely removed, thus acting as a key.



OPTION C:

Preset Counter with external reset option, complementary switching outputs and actual value display.

OPTION C1:

Instantaneous value display with analogue output, pulse-volume output and totalizer

Technical data

Sensor	magnetic-inductive	
Nominal width	DN 8..25	
Process connection	male thread R 1/4", R 1/2", R 1"	
Metering ranges	0.05..60 l/min	for details, see table "Ranges"
Measurement accuracy	0.05..1.5 l/min	
Repeatability	1 %	
Minimum electrical conductivity (medium)	50 µS/cm	
Pressure resistance	PN 10 bar	
Pressure loss	max. 0.3 bar at max. flow	
Medium temperature	0..+60 °C (avoid frost and dew)	
Ambient temperature	0..+60 °C	
Storage temperature	-20..+80 °C	
Materials medium-contact	stainless steel 1.4404, PPS, FKM	
Materials, non-medium-contact	Housing	stainless steel 1.4305
	Glass	mineral glass, hardened
	Magnet	samarium-Cobalt
	Ring	POM
Supply voltage	18..30 V DC	
Power consumption	< 1 W	
Analog output	4..20 mA / max. load 500 Ω or 0..10 V / min. load 1 kΩ	
Switching outputs	transistor output "push-pull" (resistant to short circuits and polarity reversal) I _{out} = 100 mA max.	
Hysteresis	adjustable, position of the hysteresis depends on minimum or maximum	
Display	backlit graphical LCD-Display (transreflective), extended temperature range -20..+70 °C, 32 x 16 pixels, background illumination, displays value and unit, flashing LED signal lamp with simultaneous message on the display.	
Electrical connection	for round plug connector M 12x1, 5-pole	
Ingress protection	IP 64	
Weight	R 1/4"	approx. 0.35 kg
	R 1/2"	approx. 0.35 kg
	R 1"	approx. 0.45 kg

Ranges

R	Nominal width	Metering range l/min H2O	Measurement accuracy
R 1/4"	DN 8	0.05.. 1	2.5 % of the measured value, at least 0.005 l/min
R 1/2"	DN 15	0.50..10	2.5 % of the measured value, at least 0.05 l/min
R 1"	DN 25	3.00..60	2.5 % of the measured value, at least 0.3 l/min

Signal output curves

Value x = Begin of the specified range
 = not specified range

Current output

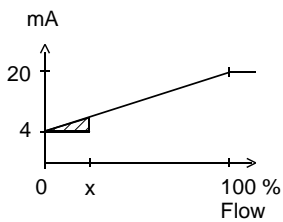

Voltage output

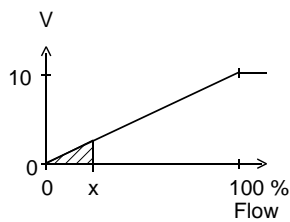

Other characters on request.

Wiring

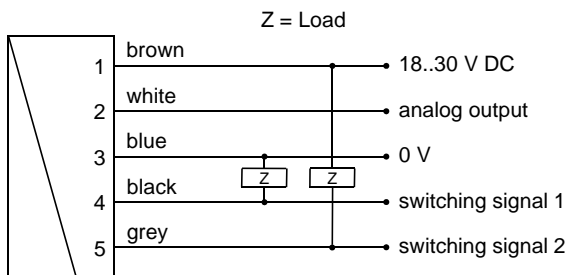

Connection example: PNP NPN

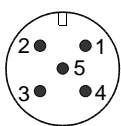

connector M12x1

See separate wiring at C and C1 option in the separate descriptions.

Before the electrical installation, it must be ensured that the supply voltage corresponds to the data sheet. The use of shielded cabling is recommended.

Dimensions

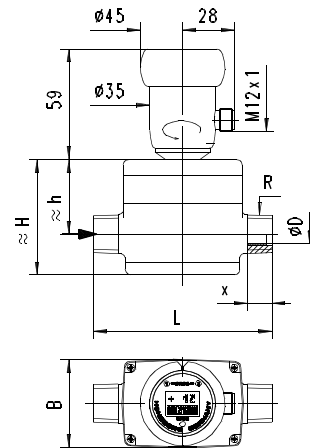

	L mm	H mm	h mm	R	x mm	B mm	D mm
OMNI-MID1-008	85	59	39	1/4"	9	47	5
OMNI-MID1-015	95	63	42	1/2"	13	47	10
OMNI-MID1-025	110	72	45	1"	16	49	20

Handling and operation

Installation

The device is screwed into the pipework by means of two male threads or into suitable connection pieces. Here, attention must be paid to the direction (arrow marked on the housing in the direction of flow). Seal using Teflon tape or a fluid seal.

Use the following torques:

- R 1/4": 3 ±0.5 Nm
- R 1/2": 5 ±0.5 Nm
- R 1": 12 ±1.0 Nm

The sensor can be operated in any location. However, air bubbles should be avoided. Direction of flow from bottom to top is recommended.

The electronics head is supplied mounted on the sensor body.

Avoid angular loading of the sensor. Pipework in which sensors are installed should be permanently flooded. 10 x D should be used in the inlet and outlet.

Programming

The annular gap of the programming ring can be turned to positions 1 and 2. The following actions are possible:



Set to 1 = continue (STEP)
 Set to 2 = modify (PROG)

Neutral position between 1 and 2

The ring can be removed to act as a key, or turned through 180° and replaced to create a programming protector. Operation is by dialog with the display messages, which makes its use very simple.

Starting from the normal display (present value and unit), if 1 (STEP) is repeatedly selected, then the display shows the following information in this order:

Display of the parameters, using position 1

- Switching value S1 (switching point 1 in the selected unit)
- Switching characteristic of S1
MIN = Monitoring of minimum value
MAX = Monitoring of maximum value
- Hysteresis 1 (hysteresis value of S1 in the set unit)
- Switching value S2
- Switching characteristic of S2
- Hysteresis 2
- Code
After entering the **code 111**, further parameters can be defined:
- Filter (settling time of the display and output)
- Physical unit (Units)
- Output: 0..20 mA or 4..20 mA
- 0/4 mA (measured value corresponding to 0/4 mA)
- 20 mA (measured value corresponding to 20 mA)

For models with a voltage output, replace 20 mA accordingly with 10 V.

Edit, using position 2

If the currently visible parameter is to be modified:

- Turn the annular gap to position 2, so that a flashing cursor appears which displays the position which can be modified.
- By repeatedly turning to position 2, values are increased; by turning to position 1, the cursor moves to the next digit.
- Leave the parameter by turning to position 1 (until the cursor leaves the row); this accepts the modification.
- If there is no action within 30 seconds, the device returns to the normal display range without accepting the modification.

The limit switches S1 and S2 can be used to monitor minimal or maximal.

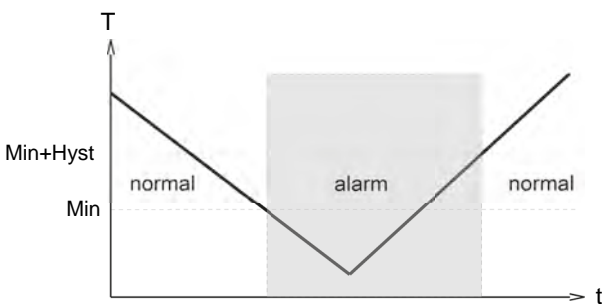

With a minimum-switch, falling below the limit value causes a switchover to the alarm state. Return to the normal state occurs when the limit value plus the set hysteresis is once more exceeded. With a maximum-switch, exceeding the limit value causes a switchover to the alarm state. Return to the normal state occurs when the measured value once more falls below the limit value minus the set hysteresis.

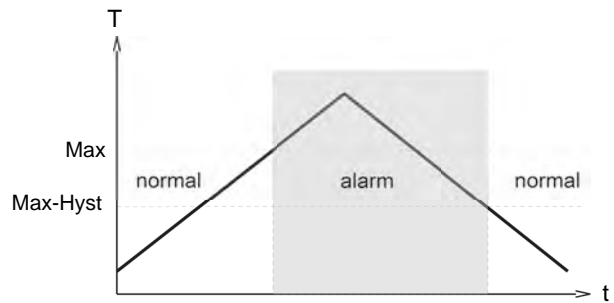

The change to the alarm state is indicated by the integrated red LED and a cleartext in the display.

While in the normal state the switching outputs are at the level of the supply voltage; in the alarm state they are at 0 V, so that a wire break would also display as an alarm state at the signal receiver.

Overload display

Overload of a switching output is detected and indicated on the display ("Check S 1 / S 2"), and the switching output is switched off.

Simulation mode

To simplify commissioning, the sensor provides a simulation mode for the analog output. It is possible to create a programmable value in the range 0..26.0 mA at the output (without modifying the process variable). This allows the wiring run between the sensor and the downstream electronics to be tested during commissioning. This mode is accessed by means of **Code 311**.

Factory settings

After modifying the configuration parameters, it is possible to reset them to the factory settings at any time using **Code 989**.

Ordering code

The basic device is ordered e.g. MID1-xxx with electronics e.g. OMNI-MID1-xxx

MID1- 1. 2. **A** 3. **P** 4. 5. **E**

OMNI-MID1- 6. 7. 8. **S** 9.

○=Option

1. Nominal width			
008	DN 8 - R 1/4"		
015	DN 15 - R 1/2"		
025	DN 25 - R 1"		
2. Process connection			
A	male thread		
3. Housing material			
P	PPS		
4. Metering range			
001	0.05.. 1 l/min		●
010	0.50..10 l/min		●
060	3.00..60 l/min	●	
5. Connection for			
E	electronics		
6. For nominal width			
008	DN 8 - R 1/4"		●
015	DN 15 - R 1/2"		●
025	DN 25 - R 1"	●	
7. Analog output			
I	current output 0/4..20 mA		●
U	○ voltage output 0/2..10 V		●
K	without		●
8. Electrical connection			
S	for round plug connector M12x1, 5-pole		
9. Option 2			
C	○ Counter C		
C1	○ Counter C1		

Options

- Counter C (hardware and software option):
Preset Counter with external reset option, complementary switching outputs and actual value display (modified wiring diagram!)
- Counter C1 (software option):
Instantaneous value display with analogue output, pulse-volume output and totalizer
- Housing material PEEK

Accessories

- Cable/round plug connector (KB...)
see additional information "Accessories"
- Device configurator EC1-1

OMNI-C Counter



Counter for flow transmitters:

- Piston
- Dynamic diaphragm
- Rotor
- Turbine
- Gear
- Screw
- Calorimetry
- MID
- Vortex

- Simple totalisation
- Simple filling counter with programmable end signal
- Control switchover at present value
- Automatic, dynamic change of display unit and decimal places in the graphics display
- Antivalent outputs
- Simple guided menu via graphics display

Characteristics

The totaliser of the OMNI flow rate system enables a totalisation or measurement of consumption for all HONSBERG device families (for fluids and gases) with which the OMNI system is compatible; this is independent of the input signal, pulse or analogue input, and of the measurement process.

Simple filling control is also possible. Here, the counter can be set to count upwards or downwards.

When the preset point is reached, a switching signal is emitted which is available in antivalent form to two outputs. Resetting can be carried out by means of a signal input or also by a programming ring.

The state of the counter is indicated in an LCD display with only four digits. Here, the number of decimal places and the unit displayed is continuously matched to the current state of the counter. In this case, the smallest value which can be displayed is 0.001 ml (= 1 µl), and the largest is 9999 m³. The counter therefore has 13 places, of which the four most significant are displayed at any one time. The display resolution at all times is therefore at least 1 per thousand of the displayed value, or better, and this generally exceeds the accuracy of the connected flow transmitter. The non-displayed digits of the counter are in that case irrelevant to the accuracy of the measurement.

The automatic dynamic changeover of units in the display in relation to the state of the counter makes the value easy to read in spite of a display with only four digits. In addition, user configuration of the counter is unnecessary.

In addition to the totalised value, the present flow rate can be displayed.

Technical data

Counter range	0.000 ml to 9999 m³ with automatic setting of the decimal places and of the applicable unit.
----------------------	---

Switching outputs (Pin 4 + 5)	signal	2 x pushpull output, max. 100 mA, resistant to short circuits and polarity reversal, antivalent states, configurable on the device as a wipe or edge signal
Counter signal (Pin 2)	reset	Input 18..30 V resistant to short circuits and reversed polarity PIN 2, wiper signal, positive or negative edge can be selected locally

Wiring

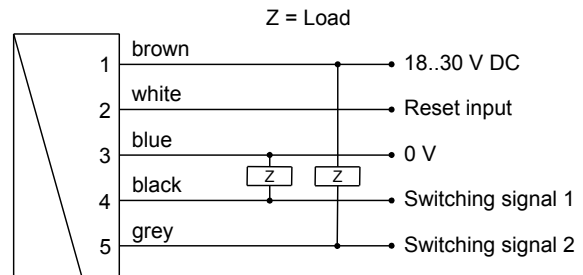

Connection example: PNP NPN

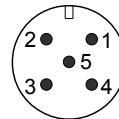

Before the connecting the supply voltage, it must be ensured that this corresponds with the data sheet! The use of shielded cabling is recommended

Sensor connection to OMNI-C-TA, see dimensions.

Handling and operation

Installation

For assembly, please observe the handling instructions for the different device versions.

After assembly, it is possible to move the sensor head to the most optimal reading position opposite the sensor part using its rotating function.

Programming

On the display, the counter indicates the state of the totaliser as a value and unit. The units ml, L, m³ are set automatically.

For operation as a totaliser, no configuration by the user is necessary.

To use the other functions, configuration may be required. This is carried out using the programming ring located on the device.



The annular gap of the programming ring can be turned to positions 1 and 2. The following actions are possible:



Set to 1 = continue (STEP)
Set to 2 = modify (PROG)

Neutral position between 1 and 2

The ring can be removed to act as a key, or turned through 180 ° and replaced to create a programming protector.

Operation is by dialogue with the display messages, which makes its use very simple.

The control display of the present flow rate depends on the metering range of the selected flow transmitter, and has already been set appropriately in the factory (ml/min, l/min, l/h, m³/h). It is activated by turning the ring to position 1. After 10 seconds, the display automatically returns to the totaliser mode.

For operation as a preset counter, the following must be set:

1. The preset point
2. The type of output signal ("Preset has been reached"):
Signal edge / wiper pulse
width of the wiper pulse, if required
3. The unit of the preset point:
(ml, litre, m³).

Starting from the normal display (total and unit), if 1 (Step) is selected repeatedly, then the counter shows the following information:

- Normal display is total and unit (e.g. litre)
- Display of present value (e.g. l/min)
- Preset point incl. type of switching output.
- Code

The code gives access to various input levels into which parameters can be entered (so that this does not occur inadvertently, the code must be entered!).

Code 111:

- Gate time (available only for sensors which transmit frequency)
- Filter time
- Direction of count (pos / neg)
- Unit for switching value reset point
- Decimal place for switching value / reset point
- Switching type for switching value (edge / wiper signal)
- Pulse duration (for wiper signal)
- Reset method (manual / via signal)

Code 100:

- Manual reset for totaliser

The detailed flow chart for operation is available in the "Operating instructions for OMNI-C".

Combination examples	
Vortex CF..	
Calorimetric F.. (separate data sheet)	
Calorimetric FG.. (separate data sheet)	
Calorimetric FIN..	
Magnetic inductive FIS.. (separate data sheet)	
Piston HD.. HR.. MR..	
Magnetic inductive MID1..	
Panel mounting OMNI-TA (separate data sheet)	
Rotor RR..	
Turbine RT..	
Screw VHS..	

Gear VHZ..	
Dynamic diaphragm XF..	

Device Configurator ECI-1



- Can be used on site for:
 - parameter modification
 - firmware update
 - adjustment of inputs and outputs
- Can be connected via USB

Characteristics

The device configurator ECI-1 is an interface which allows the connection of microcontroller-managed HONSBERG sensors to the USB port of a computer. Together with the Windows software "HONSBERG Device Configurator" it enables

- the modification of all the sensor's configuration settings
- the reading of measured values
- the adjustment of inputs and outputs
- firmware updates

Technical data

Supply voltage	12..30 V DC (depending on the connected sensor) and via USB
Power consumption	< 1 W
Connection	
Sensor	cable bushing M12x1, 5-pole, straight length approx. 50 cm
Lead	device connector M12x1, 5-pole
USB	USB bushing type B
Operating temperature	0..50 °C
Storage temperature	-20..+80 °C
Dimensions of housing	98 mm (L) x 64 mm (W) x 38 mm (H)
Housing material	ABS
Ingress protection	IP 40

Handling and operation

Connection



The device configurator is intended for temporary connection to the application. It is connected between the the existing sensor lead and the sensor. Power supply is via the supply to the sensor and the computer's USB port. When inactive (no communication), the configurator behaves completely neutrally; all signals from the sensor remain available to the application. During communication between computer and sensor, the signal wirings are separated in the configurator, so that in this state the sensor's output signals are not available.

To connect 4-pole leads without a middle hole to the installed 5-pole device connector, adapter K04-05 is included. 4-pole leads with a middle hole can be used without an adapter.

Ordering code

Device configurator (for scope of delivery, see the diagram below)	ECI-1
--	--------------

Scope of delivery

1. Device configurator ECI-1
2. USB cable
3. Adapter K04-05
4. Plug KB05G
5. Cable K05PU-02SG
6. Carrying case



Incl. software

Accessories:

Mains connector 24 V DC (with fitted round plug connector, 5-pole, incl. international plug set)	EPWR24-1
--	-----------------



Replacement parts:

M12x1 adapter 4- / 5-pole	K04-05
PUR cable, 5-pole, shielded with round plug connector M12x1	K05PU-02SG
Round plug connector M12x1, 5-pole (without cable)	KB05G

Option

OMNI - Tropical model



This OMNI electronic option should be used where temperatures change quickly, or for external installations (the device is filled with oil, and thus prevents condensate formation in the electronics housing, even under adverse circumstances)

Accessories

Filter

Type ZV



Type ZE



The HONSBERG filters are offered for the protection of the devices from dirt or as independent components for coarse and fine filtration of liquids.

For more information, see additional product information.

Round plug connector 4 / 5-pin



Ordering code

Self-assembly

1. 2.

KB

1. Number of pins	
04	4-polig
05	5-polig
2. Steckerabgang	
G	gerade
W	newinkelt 90 °

Round plug connector 4-pin



- 1 → brown
- 2 → white
- 3 → blue
- 4 → black

Ordering code

Packaged

1. 2. 3. 4. 5.
K ○= Option

1. Number of pins	
04	4-polig
2. Cable material	
PU-	PUR
3. Cable length	
02	2 m
05	5 m
10	10 m
	Others on request
4. Shielding	
S	shielding applied to coupling
U	unshielded
N	○ shielding not applied to coupling
5. Steckerabgang	
G	straight
W	elbow 90 °

Round plug connector 5-pin



- 1 → brown
- 2 → white
- 3 → blue
- 4 → black
- 5 → grey

Ordering code

Packaged

1. 2. 3. 4. 5.
K - ○= Option

1. Number of pins	
05	5-polig
2. Cable material	
PU-	PUR
3. Cable length	
02	2 m
05	5 m
10	10 m
	Others on request
4. Shielding	
S	shielding applied to coupling
U	unshielded
N	○ shielding not applied to coupling
5. Steckerabgang	
G	straight
W	elbow 90 °

Panel meter OMNI-TA



Primary Sensors
0..10 V
4..20 mA
Frequency



Converter with the same data as the OMNI in situ electronics; but as an external panel-mounting variant with IP 67 housing.

OMNI - Remote

Primary Sensors

0/2..10 V
4/0..20 mA
Frequency



Function is identical to OMNI-in situ. Connection to the sensor is, however, made by wire, and so the measurement point and display location can be apart

contact us



Headquarter

GHM Messtechnik GmbH
GHM GROUP CORPORATE
 Tenter Weg 2-8
 42897 Remscheid | GERMANY
 Phone +49 2191 9672-0
 info@ghm-group.de
 www.ghm-group.de

Centers of Competences

GHM Messtechnik GmbH
GHM GROUP – Greisinger
 Hans-Sachs-Straße 26
 93128 Regenstein | GERMANY
 Phone +49 9402 9383-0
 info@greisinger.de | www.greisinger.de

GHM Messtechnik GmbH
GHM GROUP – Honsberg
 Tenter Weg 2-8
 42897 Remscheid | GERMANY

GHM Messtechnik GmbH
GHM GROUP – Martens
 Kiebitzhörn 18
 22885 Barsbüttel | GERMANY

GHM Messtechnik GmbH
GHM GROUP – Imtron
 Carl-Benz-Straße 11
 88696 Owingen | GERMANY

Delta OHM S.r.l. a socio unico
GHM GROUP – Delta OHM
 Via Marconi 5
 35030 Caselle di Selvazzano
 Padova (PD) | ITALY
 Phone +39 049 8977150
 info@deltaohm.com
 www.deltaohm.com

Valco srl
GHM GROUP – VAL.CO
 Via Rovereto 9/11
 20014 S. Ilario di Nerviano
 Milano (MI) | ITALY
 Phone +39 0331 53 59 20
 valco@valco.it
 www.valco.it

GHM GROUP International

Austria
 GHM Messtechnik GmbH
 Office Austria
 Breitenseer Str. 76/1/36
 1140 Vienna | AUSTRIA
 Phone +43 660 7335603
 a.froestl@ghm-messtechnik.de

Brazil & Latin America
 GHM Messtechnik do Brasil Ltda
 Av. José de Souza Campos, 1073, cj 06
 Campinas, SP
 13025 320 | BRAZIL
 Phone +55 19 3304 3408
 info@grupoghm.com.br

Czech Republic / Slovakia
 GHM Greisinger s.r.o.
 Ovci hajek 2/2153
 158 00 Prague 5
 Nove Butovice | CZECH REPUBLIC
 Phone +420 251 613828
 Fax +420 251 612607
 info@greisinger.cz | www.greisinger.cz

Denmark
 GHM Maaleteknik ApS
 Maarslet Byvej 2
 8320 Maarslet | DENMARK
 Phone +45 646492-00
 Fax +45 646492-01
 info@ghm.dk | www.ghm.dk

France
 GHM GROUP France SAS
 Parc des Pivolles
 9 Rue de Catalogne
 69150 Décines-Charpieu (Lyon) | FRANCE
 Phone +33 4 72 37 45 30
 contact@ghm-group.fr

India
 GHM Messtechnik India Pvt Ltd.
 209 | Udyog Bhavan | Sonowala Road
 Gregaon (E) | Mumbai - 400 063
 INDIA
 Phone +91 22 40236235
 info@ghmgroup.in | www.ghmgroup.in

Italy for Greisinger & Delta OHM
 GHM GROUP – Delta OHM
 Via Marconi 5
 35030 Caselle di Selvazzano
 Padova (PD) | ITALY
 Phone +39 049 8977150
 a.casati@ghm-messtechnik.de

Italy for Honsberg, Martens, Valco
 GHM GROUP – Valco
 Via Rovereto 9/11
 20014 S. Ilario di Nerviano
 Milano (MI) | ITALY
 Phone +39 0331 53 59 20
 alessandro.perego@valco.it

Netherlands
 GHM Meettechnik BV
 Zeeltweg 30
 3755 KA Eemnes | NETHERLANDS
 Phone +31 35 53805-40
 Fax +31 35 53805-41
 info@ghm-nl.com | www.ghm-nl.com

South Africa
 GHM Messtechnik SA (Pty) Ltd
 16 Olivier Street
 Verwoerdpark, Alberton 1453
 SOUTH AFRICA
 Phone +27 74 4590040
 j.grobler@ghm-sa.co.za

...and more than
100 qualified distributors!



Visit us at: www.ghm-group.de