

# Differential pressure transmitter 985 with IP65



## General description

The differential pressure transmitters of the 985 series are used to measure differential pressure, overpressure and vacuum. They provide up to 8 pressure ranges and 2 output signals, which are easily selectable by jumper or rotary selector switch.

## Applications

Monitoring of gaseous, non-combustible and non-aggressive media.

Possible usage areas are:

- Building automation and air conditioning systems
- Overpressure measurement in clean rooms and laboratories
- Measurement of constant pressure in VAV applications
- Dynamic filter and ventilator monitoring

## Configurable pressure range

For an optimum adaptation to the application, the transmitter can be switched between various pressure ranges. The factory setting is the most sensitive range. For the series 985M and 985A the less sensitive second range will be selected by simply removing a jumper. For the series 985Q the available eight ranges can be selected by a rotary selector switch.

## Output signal selection

The output signal of the 3-wire version can be changed between 0 ... 10 Volt and 4 ... 20 mA by removing a jumper. The series 985M is also available in a 2-wire version with 4 ... 20 mA output signal.

## Configurable response time

The response time of the output signal can be configured using a jumper. If the jumper is in place the response time is slow (factory setting), which is useful for suppressing brief pressure peaks. If the application requires a fast response time the jumper must be removed.

## Easy offset calibration

The output signal of the 985M series can be calibrated to zero by pressing the MODE/Offset button in a pressureless state of the transmitter. The series 985A and 985Q perform an automated zero offset compensation.

## Volume flow measurement

The shape of the output signal can be switched from linear to square root using a jumper in order to measure the volume flow via a differential pressure.

**Switching output** (optional, not available with 2-wire version)

To give a switch signal at an user defined pressure level the transmitter has an adjustable transistor switching output (NPN NO) with a maximum switching capacity of 30 VDC/100 mA. NPN NC or PNP NO / NC on request.

**Display** (optional, not available with 2-wire version)

In addition to the analogue output signal the pressure value can be read out on a red LED-display in Pascal or other pressure units.

## Measuring method

Piezoresistive pressure transducer.

## Mounting position

Can be mounted in any position. The zero offset calibration eliminates any possible position error.

# Overview on technical data

Series	985M	985M	985A	985Q
Electrical connection	<b>2-wire</b>	<b>3-wire</b>	<b>3-wire</b>	<b>3-wire</b>
Measuring method	Piezoresistive pressure transducer			
Supply voltage	18...30 VDC	18...30 VAC / VDC	18 $\bar{5}$ 30 VAC / VDC	18 $\bar{5}$ 30 VAC / VDC
Output signal selectable	.	with jumper	with jumper	with jumper
Output signal 0 ... 10 V	.			
Output signal 4 ... 20 mA				
Output signal 0 ... 5 V	.			
Output signal 0 ... 20 mA	.			
LED display, red, 4 digits	.			
Switching output for max 30 VDC / 100 mA	.			
Output signal selection from linear to square root				
max. current draw without display VDC / VAC	21 / . mA	25 / 110 mA	75 / 180 mA	75 / 180 mA
max. current draw with display VDC / VAC	. / .	50 / 170 mA	100 / 230 mA	100 / 230 mA
Load for 4 ... 20 mA output	20 ... 500			
Load for 0 ... 10 V output	.	~ 1k (m10 mA)	~ 1k (m10 mA)	~ 1k (m10 mA)
Pressure medium	Air and non-combustible and non-aggressive gases			
Configuration of pressure range	with jumper	with jumper	with jumper	with rotary switch
max. number of pressure range	2	2	2	8
only one customized pressure range				
Manuel offset compensation			.	.
Automated offset compensation	.	.		
Working and storage temperature	-20 $\bar{5}$ +70°C	-20 $\bar{5}$ +70°C	-10 $\bar{5}$ +50°C	-10 $\bar{5}$ +50°C
Linearity (incl. hysteresis and repeatability)	m $\pm$ 0.5% FS, min. $\pm$ 1 Pa			
Uncertainty (Total Error Band w/o long-term and temperature effects)	$\pm$ 1% FS, min. $\pm$ 1 Pa			
Long-term stability	m $\pm$ 1% FS	m $\pm$ 1% FS	n.r.	n.r.
Humidity	0 ... 95% rel, non-condensing			
Response time 0.2 s and 1 s (standard)				
Response time free selectable between 0.2 s and 20 s				
Process connection P1 and P2	Hose connection with 4 / 6 mm outer diameter			
Electrical connection	Plug-in terminals for wires and strands up to 1.5 mm <sup>2</sup> or circular connector M12 / 4-pole			
Housing material	ABS			
Housing dimensions	approx. 81 x 83 x 41 mm			
Weight	approx. 110 gr	approx. 125 gr	approx. 140 gr	approx. 140 gr
Cable conduit	Cap nut conduit AF15 made of polyamide			
Protection class acc. to EN 60529	IP65			
CE Conformance acc. to EN 61326				
RoHS Conformance acc. to 2011/65/EU				

Accuracy specifications according to EN 60770 based on the pressure measurement at 23 °C

standard equipment

optional equipment

# Differential pressure transmitter 985M

with manual offset compensation and 2 pressure ranges

## Pressure ranges

Model	Range 1	Range 2	Overload capacity	Bursting pressure	Additional uncertainty with temperature [% FS/10K]
985M.3X3	-50 ÷ 0 ÷ +50 Pa	-	60 kPa	100 kPa	± 1.0
985M.3W3	-100 ÷ 0 ÷ +100 Pa	-	60 kPa	100 kPa	± 0.7
985M.323	0 ÷ 100 Pa	0 ÷ 250 Pa	60 kPa	100 kPa	± 0.7
985M.333	0 ÷ 250 Pa	0 ÷ 500 Pa	60 kPa	100 kPa	± 0.5
985M.343	0 ÷ 500 Pa	0 ÷ 1000 Pa	75 kPa	125 kPa	± 0.3
985M.353	0 ÷ 1 kPa	0 ÷ 2.5 kPa	85 kPa	135 kPa	± 0.3
985M.373	0 ÷ 5 kPa	0 ÷ 10 kPa	85 kPa	135 kPa	± 0.3
985M.393	0 ÷ 25 kPa	0 ÷ 50 kPa	200 kPa	400 kPa	± 0.3
985M.3A3	0 ÷ 50 kPa	0 ÷ 100 kPa	200 kPa	400 kPa	± 0.3

Further pressure ranges on request.

## Order matrix

Configurable pressure range	<b>- 50 ... 0 ... +50 Pa (-0.5 ... 0 ... +0.5 mbar)</b> <b>- 100 ... 0 ... +100 Pa (-1.0 ... 0 ... +1.0 mbar)</b> <b>0 ... 100 Pa ( 1.0 mbar)</b> <b>0 ... 250 Pa ( 2.5 mbar)</b> <b>0 ... 500 Pa ( 5.0 mbar)</b> <b>0 ... 1 kPa ( 10 mbar)</b> <b>0 ... 5 kPa ( 50 mbar)</b> <b>0 ... 25 kPa (250 mbar)</b> <b>0 ... 50 kPa (500 mbar)</b> 0 ... 250 Pa ( 2.5 mbar) 0 ... 500 Pa ( 5.0 mbar) 0 ... 1000 Pa ( 10 mbar) 0 ... 2.5 kPa ( 25 mbar) 0 ... 10 kPa (100 mbar) 0 ... 50 kPa (500 mbar) 0 ... 100 kPa ( 1.0 bar)	985M.3	X					
Pressure unit	mbar Pa				1 3			
Output signal and version	<b>0 ... 10 V</b> or 4 ... 20 mA, 3-wire, with switching output <b>0 ... 10 V</b> or 4 ... 20 mA, 3-wire, without switching output <b>4 ... 20 mA</b> or 0 ÷ 10 V, 3-wire, with switching output <b>4 ... 20 mA</b> or 0 ÷ 10 V, 3-wire, without switching output <b>4 ... 20 mA</b> , 2-wire				1 7 3 D 2			
Display	no display with LED-display, 4 digits (only for 3-wire)					0 1		
Electrical connection	via plug-in terminals via circular connector M12 / 4-pole							4b 8b

Factory settings printed in bold type.

## Terminal assignments

**Plug-in terminals**  
2- or 4-pole

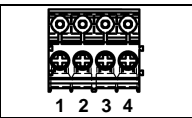

**Circular connector**  
M12 4-pole

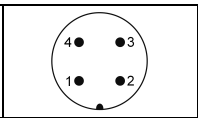

**3-wire with switching output**

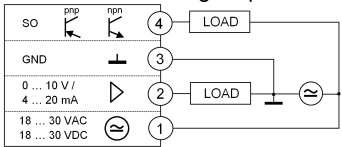

4	Switching output (SO)
3	Ground (GND)
2	Output signal (0÷ 10 V / 4÷ 20 mA)
1	Supply voltage (18...30 VAC / VDC)

**3-wire without switching output**

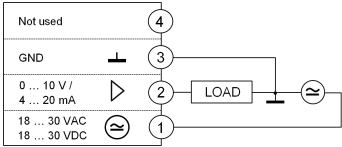

4	Not used
3	Ground (GND)
2	Output signal (0÷ 10 V / 4÷ 20 mA)
1	Supply voltage (18...30 VAC / VDC)

**2-wire**

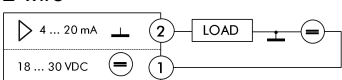

2	Output signal (4÷ 20 mA)
3	Not used
4	Not used
1	Supply voltage (18...30 VDC)

# Differential pressure transmitter 985A

with automated offset compensation and 2 pressure ranges

## Pressure ranges

Model	Range 1	Range 2	Overload capacity	Bursting pressure	Additional uncertainty with temperature [% FS/10K]
985A.3E3	-25 ÷ 0 ÷ +25 Pa	-	60 kPa	100 kPa	± 0.7
985A.3X3	-50 ÷ 0 ÷ +50 Pa	-	60 kPa	100 kPa	± 0.5
985A.3W3	-100 ÷ 0 ÷ +100 Pa	-	60 kPa	100 kPa	± 0.3
985A.303	0 ÷ 25 Pa	0 ÷ 50 Pa	60 kPa	100 kPa	± 0.7
985A.313	0 ÷ 50 Pa	0 ÷ 100 Pa	60 kPa	100 kPa	± 0.5
985A.323	0 ÷ 100 Pa	0 ÷ 250 Pa	60 kPa	100 kPa	± 0.3
985A.333	0 ÷ 250 Pa	0 ÷ 500 Pa	60 kPa	100 kPa	n.r.
985A.343	0 ÷ 500 Pa	0 ÷ 1000 Pa	75 kPa	125 kPa	n.r.
985A.353	0 ÷ 1 kPa	0 ÷ 2.5 kPa	85 kPa	135 kPa	n.r.
985A.373	0 ÷ 5 kPa	0 ÷ 10 kPa	85 kPa	135 kPa	n.r.
985A.393	0 ÷ 25 kPa	0 ÷ 50 kPa	200 kPa	400 kPa	n.r.

Further pressure ranges on request.

## Order matrix

Configurable pressure range	- 25 ... 0 ... +25 Pa - 50 ... 0 ... +50 Pa - 100 ... 0 ... +100 Pa <b>0 ... 25 Pa ( 0.25 mbar)</b> <b>0 ... 50 Pa ( 0.5 mbar)</b> <b>0 ... 100 Pa ( 1.0 mbar)</b> <b>0 ... 250 Pa ( 2.5 mbar)</b> <b>0 ... 500 Pa ( 5.0 mbar)</b> <b>0 ... 1 kPa ( 10 mbar)</b> <b>0 ... 5 kPa ( 50 mbar)</b> <b>0 ... 25 kPa (250 mbar)</b>	(-0.25 ... 0 ... +0.25 mbar) (-0.5 ... 0 ... +0.5 mbar) (-1.0 ... 0 ... +1.0 mbar) 0 ... 50 Pa ( 0.5 mbar) 0 ... 100 Pa ( 1.0 mbar) 0 ... 250 Pa ( 2.5 mbar) 0 ... 500 Pa ( 5.0 mbar) 0 ... 1000 Pa ( 10 mbar) 0 ... 2.5 kPa ( 25 mbar) 0 ... 10 kPa (100 mbar) 0 ... 50 kPa (500 mbar)	<b>985A.3</b>	E X W 0 1 2 3 4 5 7 9				
Pressure unit	mbar Pa				1 3			
Output signal and version	<b>0 ... 10 V</b> or 4 ... 20 mA, 3-wire, with switching output <b>0 ... 10 V</b> or 4 ... 20 mA, 3-wire, without switching output <b>4 ... 20 mA</b> or 0 ÷ 10 V, 3-wire, with switching output <b>4 ... 20 mA</b> or 0 ÷ 10 V, 3-wire, without switching output					1 7 3 D		
Display	no display with LED-display, 4 digits						0 1	
Electrical connection	via plug-in terminals via circular connector M12 / 4-pole							4b 8b

Factory settings printed in bold type.

## Terminal assignments

### 3-wire with switching output

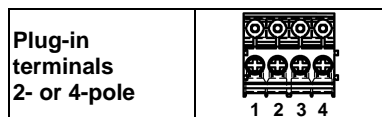
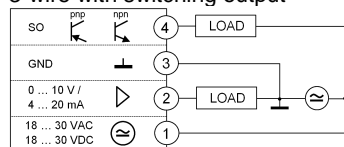

4	Switching output (SO)
3	Ground (GND)
2	Output signal (0÷ 10 V / 4÷ 20 mA)
1	Supply voltage (18...30 VAC / VDC)

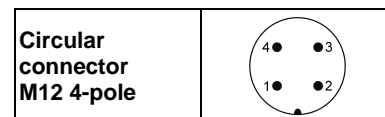

2	Switching output (SO)
3	Ground (GND)
4	Output signal (0÷ 10 V / 4÷ 20 mA)
1	Supply voltage (18...30 VAC / VDC)

### 3-wire without switching output

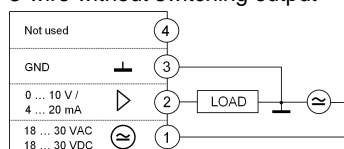

4	Not used
3	Ground (GND)
2	Output signal (0÷ 10 V / 4÷ 20 mA)
1	Supply voltage (18...30 VAC / VDC)

2	Not used
3	Ground (GND)
4	Output signal (0÷ 10 V / 4÷ 20 mA)
1	Supply voltage (18...30 VAC / VDC)

# Differential pressure transmitter 985Q

with automated offset compensation and 8 pressure ranges

## Pressure ranges

Model	Position rotary switch	Pressure ranges	Overload capacity	Berstdruck	Additional uncertainty with temperature [% FS/10K]
985Q.343	1	0 $\bar{\delta}$ 100 Pa	75 kPa	125 kPa	$\pm 0.7$
	2	0 $\bar{\delta}$ 250 Pa	75 kPa	125 kPa	$\pm 0.3$
	3	0 $\bar{\delta}$ 500 Pa	75 kPa	125 kPa	n.r.
	4	0 $\bar{\delta}$ 1000 Pa	75 kPa	125 kPa	n.r.
	5	-50 $\bar{\delta}$ 0 $\bar{\delta}$ +50 Pa	75 kPa	125 kPa	$\pm 0.7$
	6	-100 $\bar{\delta}$ 0 $\bar{\delta}$ +100 Pa	75 kPa	125 kPa	$\pm 0.5$
	7	-250 $\bar{\delta}$ 0 $\bar{\delta}$ +250 Pa	75 kPa	125 kPa	n.r.
	8	-500 $\bar{\delta}$ 0 $\bar{\delta}$ +500 Pa	75 kPa	125 kPa	n.r.
	0	fixed output signal 0 V / 4 mA	-	-	-
9	fixed output signal 10 V / 20 mA	-	-	-	
985Q.353	1	-100 $\bar{\delta}$ 0 $\bar{\delta}$ +100 Pa	85 kPa	125 kPa	$\pm 1.0$
	2	0 $\bar{\delta}$ 100 Pa	85 kPa	125 kPa	$\pm 1.5$
	3	0 ... 200 Pa	85 kPa	125 kPa	$\pm 1.0$
	4	0 ... 500 Pa	85 kPa	125 kPa	$\pm 0.5$
	5	0 ... 1000 Pa	85 kPa	125 kPa	$\pm 0.3$
	6	0 ... 1500 Pa	85 kPa	125 kPa	n.r.
	7	0 ... 2000 Pa	85 kPa	125 kPa	n.r.
	8	0 ... 2500 Pa	85 kPa	125 kPa	n.r.
	0	fixed output signal 0 V / 4 mA	-	-	-
9	fixed output signal 10 V / 20 mA	-	-	-	

Factory settings printed in bold type.

## Order matrix

Configurable pressure range	see pressure ranges <b>max. 1000 Pa (10 mbar)</b> <b>max. 2500 Pa (25 mbar)</b>	<b>985Q.3</b>	4				
Pressure unit	mbar Pa		5	1			
Output signal and version	<b>0 ... 10 V</b> or 4 ... 20 mA, 3-wire, with switching output <b>0 ... 10 V</b> or 4 ... 20 mA, 3-wire, without switching output <b>4 ... 20 mA</b> or 0 $\bar{\delta}$ 10 V, 3-wire, with switching output <b>4 ... 20 mA</b> or 0 $\bar{\delta}$ 10 V, 3-wire, without switching output			3	1	7	
Display	no display with LED-display, 4 digits				D		0
Electrical connection	via plug-in terminals via circular connector M12 / 4-pole						1
							4b
							8b

Factory settings printed in bold type.

## Terminal assignments

### 3-wire with switching output

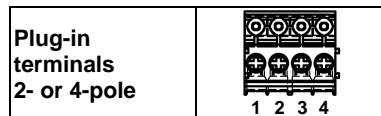
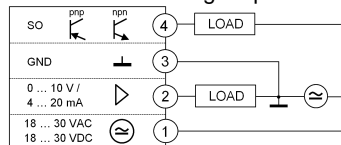

4	Switching output (SO)
3	Ground (GND)
2	Output signal (0 $\bar{\delta}$ 10 V / 4 $\bar{\delta}$ 20 mA)
1	Supply voltage (18...30 VAC / VDC)

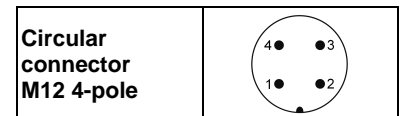

2	Switching output (SO)
3	Ground (GND)
4	Output signal (0 $\bar{\delta}$ 10 V / 4 $\bar{\delta}$ 20 mA)
1	Supply voltage (18...30 VAC / VDC)

### 3-wire without switching output

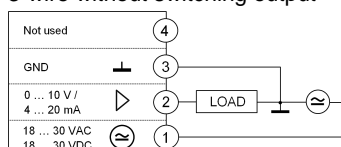

4	Not used
3	Ground (GND)
2	Output signal (0 $\bar{\delta}$ 10 V / 4 $\bar{\delta}$ 20 mA)
1	Supply voltage (18...30 VAC / VDC)

2	Not used
3	Ground (GND)
4	Output signal (0 $\bar{\delta}$ 10 V / 4 $\bar{\delta}$ 20 mA)
1	Supply voltage (18...30 VAC / VDC)

# Dimensional Drawings

## 985 with cap nut conduit AF15

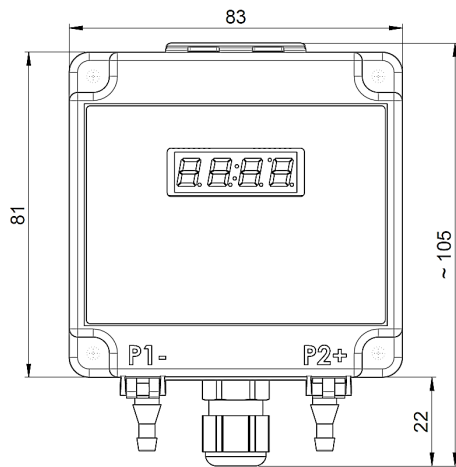
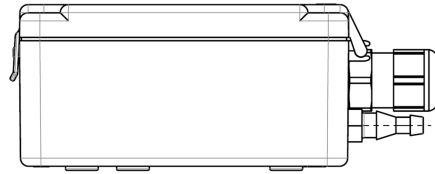
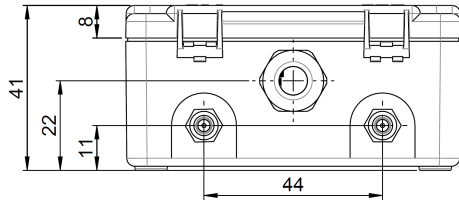

## Drilling template

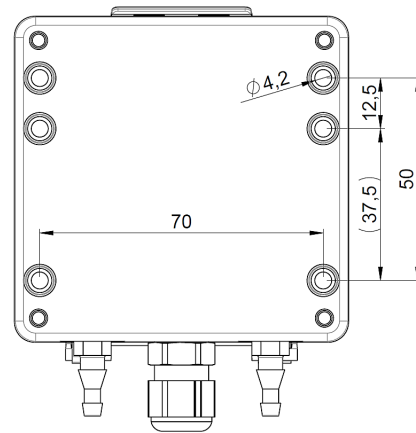

## Duct connection for Climaset® 6550/6556

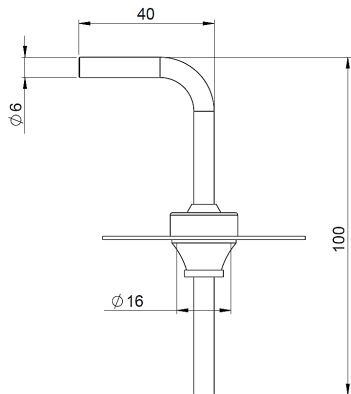

## Duct connection for Climaset® 6555/6557

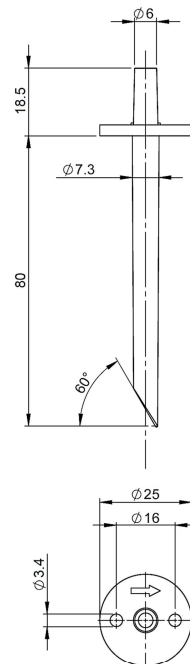

## Analog output signal

Linear (Jumper 3 closed)

0 . 10 V

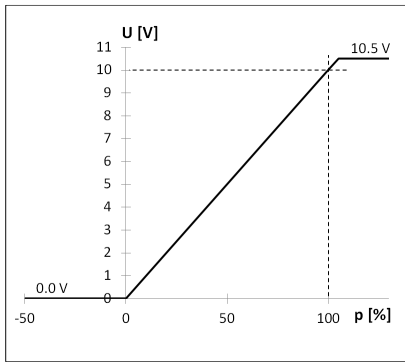

Square root (Jumper 3 open)

0 . 10 V

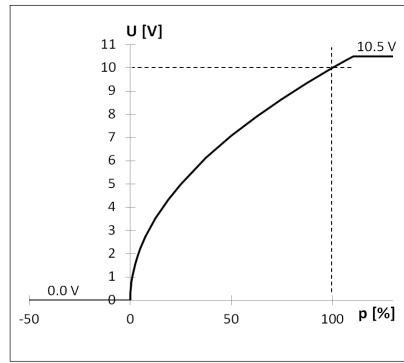

4 . 20 mA

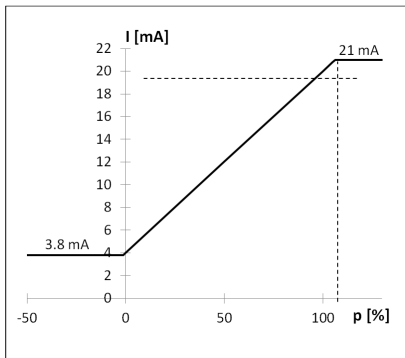

4 . 20 mA

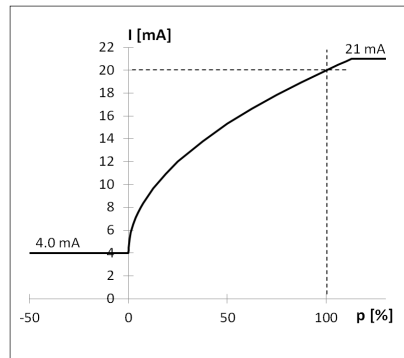

Copyright© 2021 Beck Sensortechnik GmbH

Technical data subject to change without prior notice.

985\_data\_english 7051-3

## Accessories

Climaset® consisting of 2m PVC hose and 2 plastic pipes	Article No. 6555
Climaset® consisting of 2m Silicone hose and 2 plastic pipes	Article No. 6557
Climaset® consisting of 2m PVC hose and 2 angled metal pipes	Article No. 6550
Climaset® consisting of 2m Silicone hose and 2 angled metal pipes	Article No. 6556
Duct connecting pipe for Climaset® 6555	Article No. 6551
Angled metal pipe for Climaset® 6550	Article No. 6552
Rubber grommet for Climaset® 6550	Article No. 6553
Roll with 100 m PVC hose	Article No. 6424
Roll with 100 m Silicone hose	Article No. 6425



Beck Sensortechnik GmbH  
 Ferdinand-Steinbeis-Str. 4  
 P.O. Box 1131  
 71144 Steinenbronn  
 Telephone: +49 (7157) 5287-0  
 Telefax: +49 (7157) 5287-83  
 E-Mail: sales@beck-sensors.com  
<http://www.beck-sensors.com>